

Table of Contents

Disclaimers.....	ii
Safety Precautions.....	iii
Classifications.....	iv
General Cleaning Tips	v
Scrap Computer Recycling.....	vi
SECTION 1 INTRODUCTION.....	1
1.1 General Descriptions	1
1.2 System Specifications	3
1.2.1 CPU	3
1.2.2 I/O System	3
1.2.3 System Specifications.....	4
1.2.4 Driver CD Contents.....	6
1.3 Dimensions	7
1.3.1 System Dimensions.....	7
1.3.2 Wall-mount Bracket Dimensions	8
1.3.3 Din-Rail Bracket Dimensions.....	10
1.4 I/O Outlets.....	12
1.5 Packing List.....	13
1.6 Model List	13
SECTION 2 HARDWARE INSTALLATION	15
2.1 Installation of CPU	15
2.2 Installation of 2.5" SATA Device	21
2.3 Installation of M.2 Key B Mini PCIe Module (CN20)	22
2.4 Installation of Mini PCIe Module (CN23)	24
2.5 Installation of M.2 Key E Mini PCIe Module (CN19)	27
2.6 Installation of Optional MXM Graphic Module (SCN4).....	29
2.7 Installation of NVMe SSD Module (SCN1)	31
2.8 Installation of External FAN kit (CN2).....	32
SECTION 3 JUMPER & CONNECTOR SETTINGS.....	35
3.1 Locations of Jumpers & Connectors.....	35
3.2 Summary of Jumper Settings.....	37
3.2.1 Restore BIOS Optimal Defaults (JP1)	37
3.3 Connectors.....	38
3.3.1 DC-in Phoenix Power Connector (CN1).....	39
3.3.2 HDMI Connector (CN28, CN34).....	39
3.3.3 DisplayPort++ 1.2a Connector (CN28).....	40
3.3.4 DisplayPort Connector (CN27)(optional, via MXM module)	40
3.3.5 Serial Port Connector (CN4,CN5).....	41
3.3.6 USB 3.2 Connector (CN29, CN8, CN7)	41
3.3.7 Ethernet Connector (LAN1~LAN4).....	42
3.3.8 ATX Power On/Off (SW2)	43
3.3.9 Reset Switch (SW3)	43
3.3.10 Remote Power Switch Connector (CN31)	43
3.3.11 FAN Kit Connector (CN2)(optional)	43
3.3.12 S ATA Connector (CN10 & CN15)	44
3.3.13 SATA Power Connector (CN12,CN16).....	44
3.3.14 SIM Card Slots (CN22, CN26)	44

3.3.15	Full-Size PCI Express Mini Card Slot (CN23)	45
3.3.16	M.2 3052 Key B slot (CN20)	46
3.3.17	M.2 2230 Key E slot (CN19)	47
3.3.18	M.2 2230 Key M slot (SCN1)	48
3.3.19	HD Audio Digital Header (CN32, CN33)	48
3.3.20	Digital I/O (CN13 and CN14) (optional)	49
SECTION 4 BIOS SETUP UTILITY		51
4.1	Starting	51
4.2	Navigation Keys	51
4.3	Main Menu	52
4.4	Advanced Menu	53
4.5	Chipset Menu	71
4.6	Boot Menu	77
4.7	Save & Exit Menu	78
APPENDIX A WATCHDOG TIMER		81
A.1	About Watchdog Timer	81
A.2	Sample Program	81
APPENDIX B CONFIGURING SATA FOR RAID		85
B.1	Configuring SATA Hard Drive(s) for RAID	85

SECTION 1 INTRODUCTION



This section contains general information and detailed specifications of the .Section 1 consist of the following sub-sections:

- General Descriptions
- System Specifications
- Dimensions
- I/O Outlets
- Packing List
- Model List

1.1 General Descriptions

The is a rugged & Powerful GPU Computing fanless embedded system that features the 13th/12th generation Intel® Core™ i9/i7/i5/i3 & Celeron® with Intel® R680E chipset. It comes with an IP40-rated heavy-duty aluminum extrusion design, offers 9-36V DC power input with power protection, and supports -40°C to +65°C extended temperature range*, thus enabling reliable operation in harsh environments.

To minimize deployment time, supports one flexible I/O window for customers to easily install additional I/O output. It also supports multiple I/O connections including 4 LAN ports (3*2.5G + 1*Gbe), 6 USB 3.2 ports, 4 COM ports, max up to 5 display (via MXM module), plus 2 SIM slots are provided for remarkable mobile availability. It is making perfectly suitable for Smart Manufacturing, Smart Surveillance, Machine Vision, Robotic Control, etc.

Features

- 13th/12th Gen Intel® Core™ i9/i7/i5/i3 and Celeron® processors with Intel® R680E chipset (Alder Lake S)
- Dual DDR5 SO-DIMM for up to 64GB of memory
- 4 LAN with optional PoE supported
- Dual 2.5" SATA HDD drive bays with RAID 0 & 1
- Supports MXM 3.1 Type A, up to 5 display outputs
- -40 °C to +65°C wide operating temperatures
- Wide range power input from 9 to 36 VDC
- Flexible I/O window supported via mPCIe modules

Reliable and Stable Design

The embedded system supports LGA1700 13th/12th gen Intel® Core™ i9/i7/i5/i3 and Celeron® 35 or 65 watt processors, along with high flexibility and multi-functional design that make it the best solution for AMR, Robotics, Embedded Controller, Machine Vision, OT Server applications.

Flexible Connectivity

The comes with rich I/O interfaces including two RS-232/422/485 ports, two RS-232, six USB 3.2 ports, four GbE ports, two HDMI, one DisplayPort and flexible I/O window supported.

Embedded O.S. Supported

The with 13th/12th generation platform supports Windows® 10/11, Windows® 10/11 IoT and Linux.

Various Storage Supported

In terms of storage, the supports two 2.5" SATA storage drive bay, one mSATA and one NVMe devices.

1.2 System Specifications

1.2.1 CPU

- **CPU (13th gen, 35W/65W)**
 - Intel® Core™ i3-13100TE (35W)
 - Intel® Core™ i9-13900E (65W)
- **CPU (12th gen, 35W/65W)**
 - Intel® Core™ i5-12500E (65W)
 - Intel® Core™ i5-12500TE (35W)
 - Intel® Core™ i9-12900E (65W)
 - Intel® Core™ i3-12100TE (35W)
- **Chipset**
 - Intel® R680E
- **BIOS**
 - American Megatrends Inc. UEFI (Unified Extensible Firmware Interface) BIOS.
- **System Memory**
 - 2 x 262-pin DDR5-4800 SO-DIMM, up to 64GB

1.2.2 I/O System

- **Display**
 - 2 x HDMI 1.4b (Resolution: 4096x2160@30Hz)(1 x lockable)
 - 1 x DisplayPort++ 1.2a (Resolution: 4096x2160@60Hz)
 - 2 x DisplayPort 1.4a via optional MXM type A
- **Ethernet**
 - 3 x 2.5 GbE (Intel® i226-IT)
 - 1 x GbE LAN (Intel® i219-LM)
- **USB Ports**
 - 6 x USB 3.2 Gen 2x1 (10Gbps)
- **Serial Ports**
 - 2 x RS-232/422/485 with autoflow (COM1~COM2)
 - 2 x RS-232 (COM3~COM4)

Baud rate support up to 115200
- **Audio**
 - 1 x Audio (MIC-in/Line-out)
- **Expansion Interface**
 - 1 x Full-size PCI Express Mini Card slot (USB 2.0+PCIe+SIM mSATA signal)
 - 1 x M.2 Key M 2280 socket (for storage)(PCIex4 signal)
 - 1 x M.2 Key E 2230 socket (for Wi-Fi 6E) (USB 2.0 signal)
 - 1 x M.2 Key B 3052 socket (for 5G) (PCIex1 +USB 3.0 signal)
 - 1 x Internal SIM slot for PCIe Mini Card slot
 - 1 x MXM3.1 type A connector

- **Storage**
 - 2 x 2.5" SATA HDD/SSD (up to 15 mm height; RAID 0,1 supported)
 - 1 x NVMe by M.2 Key M 2280
 - 1 x mSATA (enable in BIOS setting)

- **Flexible I/O Window**
 - Default : 2 x DB9 half cut bracket

- **Indicator**
 - 1 x Green LED for system power
 - 1 x Orange LED for HDD active
 - 4 x Programmable Green LED

- **Switch**
 - 1 x ATX PWR switch
 - 1 x Remote PWR switch
 - 1 x Reset switch

- **Antenna & SIM**
 - 5 x SMA type connector openings for antenna
 - 1 x front access SIM slot (for M.2 Key B)

- **TPM 2.0**
 - 1 x ST33HTPH2E32AHA6

1.2.3 System Specifications

● System Block diagram

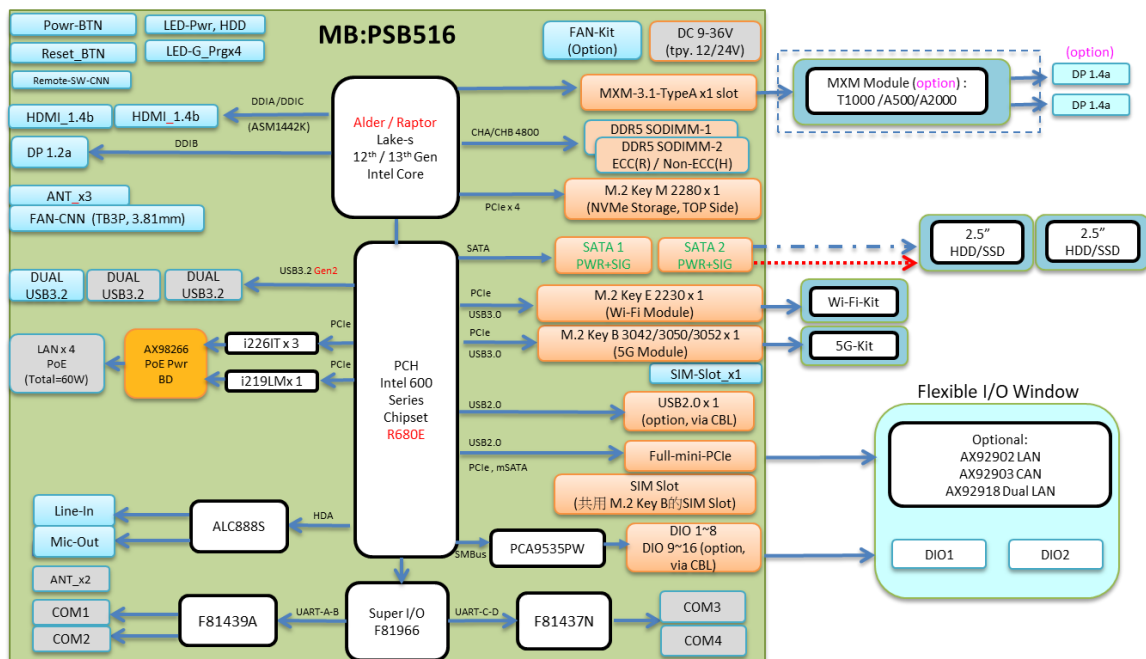

- **Watchdog Timer**
 - 1~255 seconds or minutes; up to 255 levels.

- **Power Supply**
 - 9-36V DC input with ignition

- **Operation Temperature**
 - **Without MXM module (for CPU 35W/65W)**
 - -40°C to +65°C (-40°F to +140°F) (with W.T. DRAM & SSD)

 - **With MXM module (only for CPU 35W) :**
 - For W.T MXM T1000 & A500
 - -40°C to +50°C (-40°F to +122°F) (with W.T. DRAM & SSD)

 - **With MXM module (only for CPU 35W) :**
 - For W.T MXM A2000 and must with optional FAN kit
 - -40°C to +50°C (-40°F to +122°F) (with W.T. DRAM & SSD)

- **Storage Temperature**
 - -40°C ~+80°C (-40 °F ~ 176°F)

- **Humidity**
 - 10% ~ 95% (non-condensation)

- **Shock**
 - IEC 60068-2-27 (w/SSD: 50G@wall mount, half sine,11 ms duration)

- **Vibration Endurance**
 - IEC 60068-2-64 (w/SSD: 3Grms STD, random, 5 - 500 Hz,1 hr/axis)

- **Weight**
 - 4.2 kg (9.25 lb) without package
 - 5 kg (11.02 lb) with package

- **Dimension**
 - 280 mm (11.02") (W) x 210 mm (8.26") (D) x 80.5 mm (3.16") (H)

1.2.4 Driver CD Contents

- Ethernet
- Chipset
- Graphic
- Serial Port
- Intel® ME
- Intel Rapid Storage Technology
- Audio
- MXM Driver (optional)



【Note】 : *All specifications and images are subject to change without notice.*

1.3 Dimensions

The following diagrams show dimensions and outlines of the .

1.3.1 System Dimensions

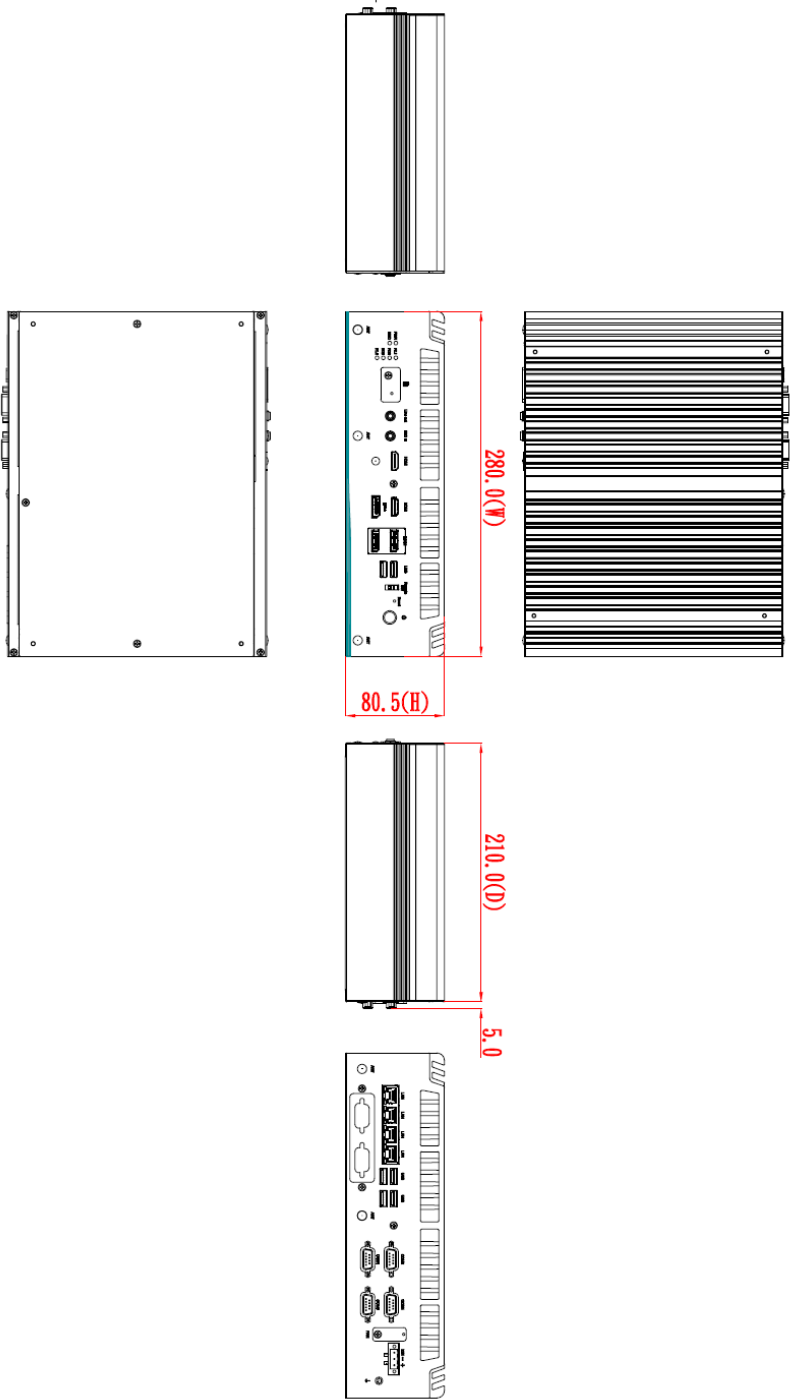

1.3.2 Wall-mount Bracket Dimensions

Users can get 6pcs truss head M3*6L screws for fixing the wall mount kit from the accessories box.

Note: When users install wall mount kit, please turn the LAN ports side outlet towards the floor.

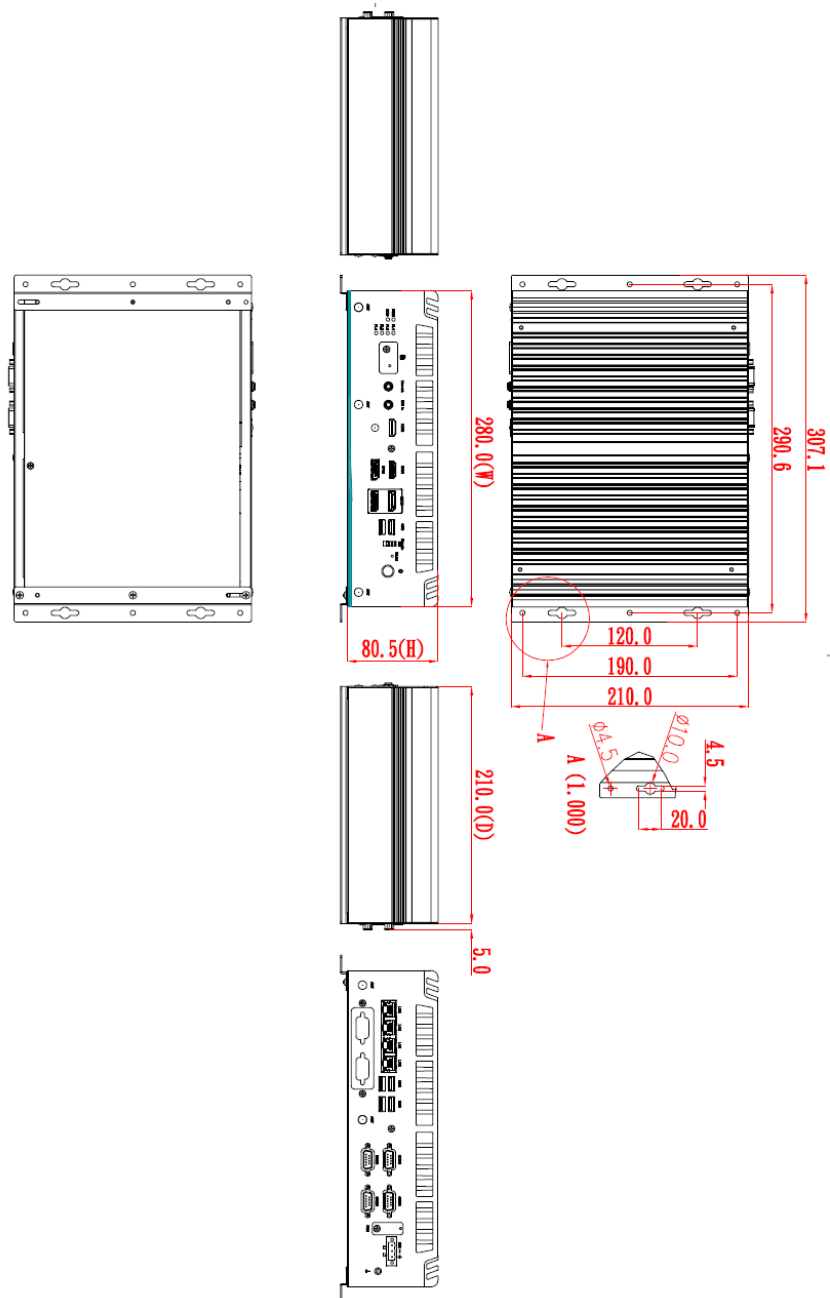

Wall-mount Bracket Assembly Drawing

Users can get 6pcs truss head M3*6L screws for fixing the wall mount kit from the accessories box.

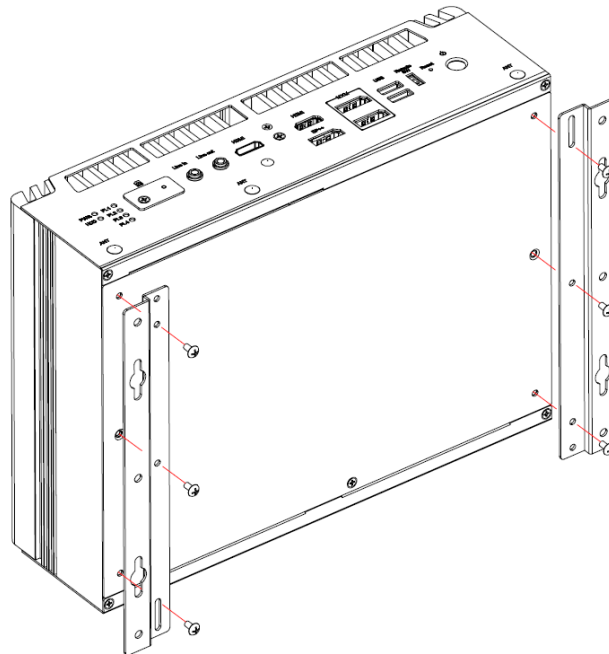

Note : If users install the screws in drywall, use the hollow wall anchors to ensure that unit does not pull away from the wall due to prolonged strain between the cable and power connector.

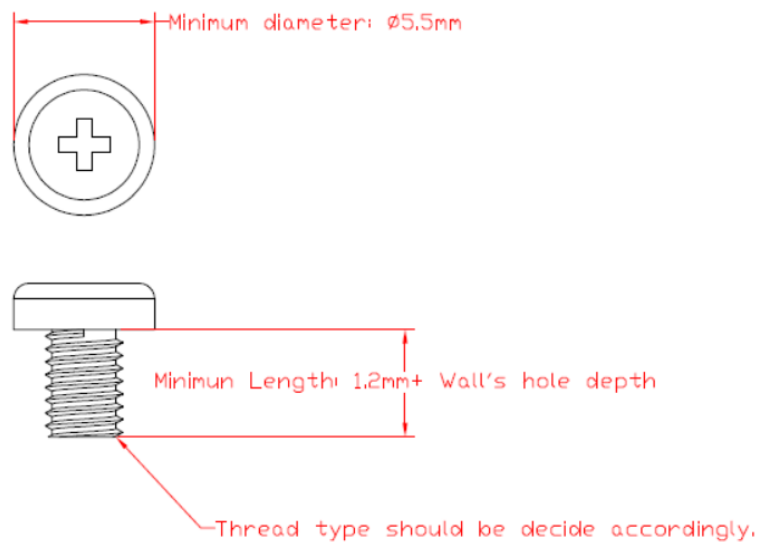

1.3.3 Din-Rail Bracket Dimensions

Users can get 6pcs truss head M3*6L screws for fixing the wall mount kit from the accessory box.

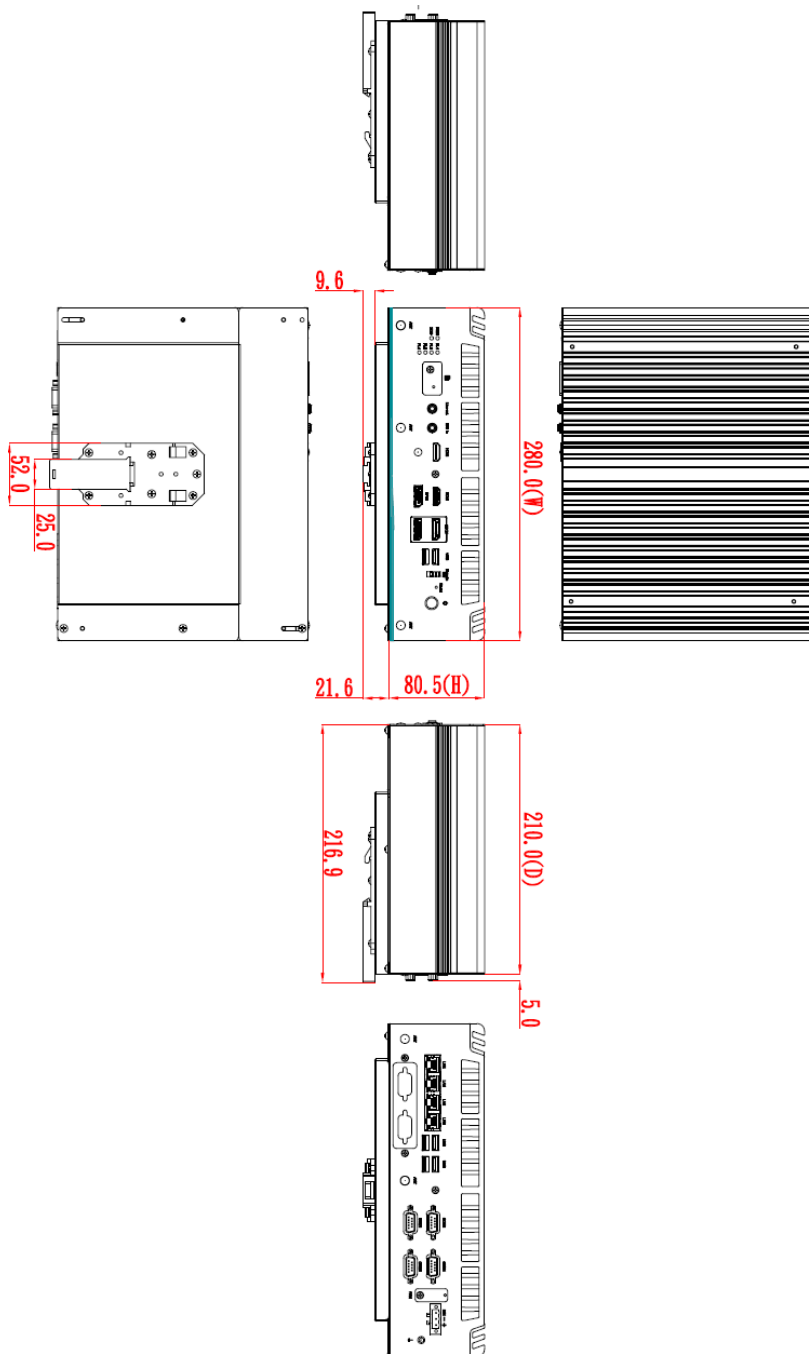

Din-Rail Bracket Assembly Drawing

Users can get 6pcs truss head M3*6L screws for fixing the wall mount kit from the accessory box.

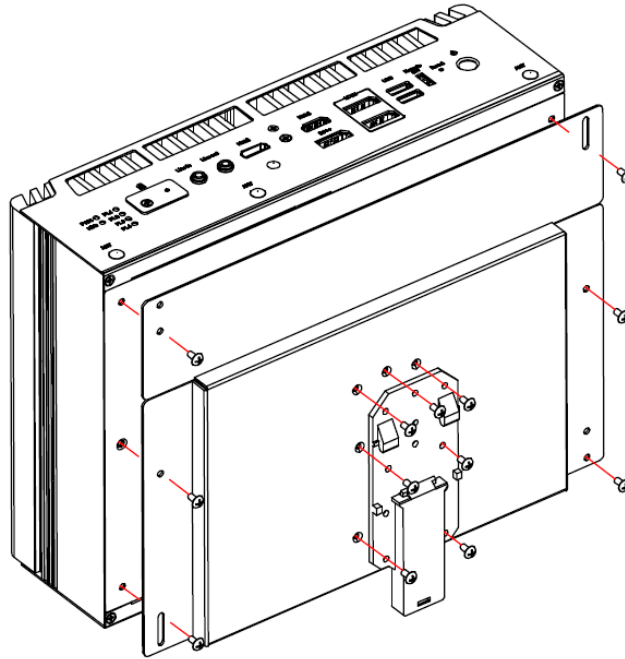

1.4 I/O Outlets

The following figures show I/O outlets on the

Front View

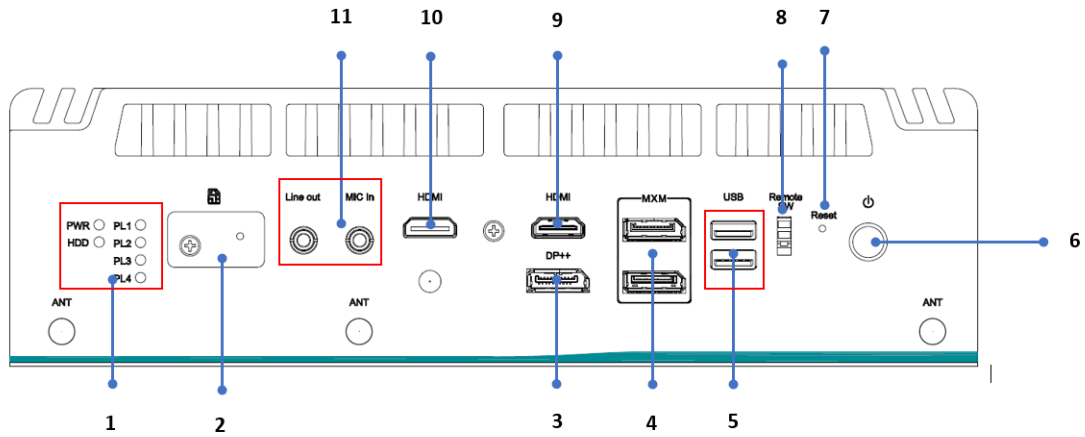

Rear View

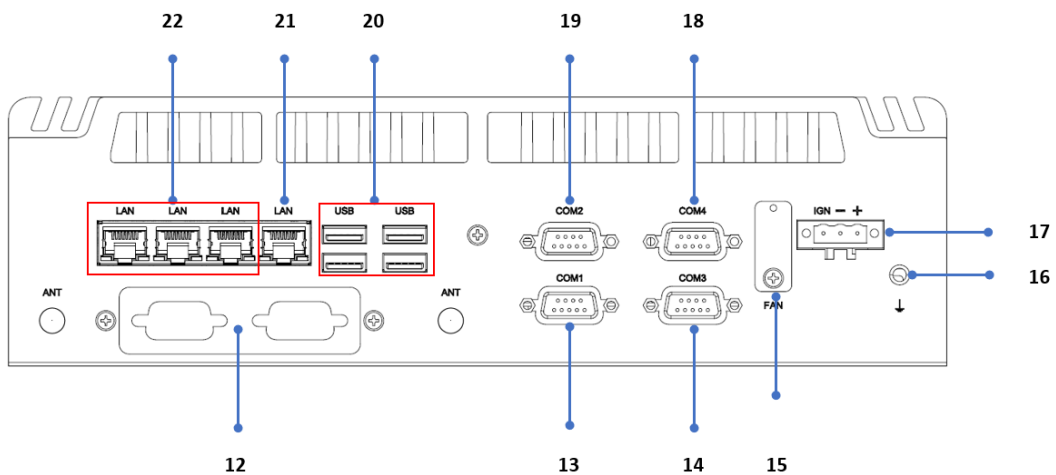

1	LEDs	11	Audio (Line in/Mic out)
2	1 x Front Access SIM slot	12	Flexible IO window
3	1 x DisplayPort++	13	RS232/422/485 (COM1)
4	Optional 2 x optional DP (via MXM module)	14	RS232(COM3)
5	2 x USB 3.2	15	Optional FAN kit connector
6	Power switch	16	Chassis Grounding screw
7	Reset switch	17	Phoenix type power input
8	Remote switch connector	18	RS232 (COM4)
9	1 x HDMI	19	RS232/422/485 (COM2)
10	1 x HDMI (lockable)	20	4 x USB 3.2
21	1 x LAN (i219-LM)	22	3 x LAN (i226-AT)

1.5 Packing List

The _____ comes with the following bundle package:

- **System Unit x 1**
- **Thermal grease x 1**
- **3-pin terminal block connector x 1**
- **Remote power switch cable x 1**
- **Foot pad x 4**
- **HDD bracket x 2**
- **Screw pack x 1**
- **DRAM thermal pad x 2**

1.6 Model List

	Fanless embedded system with LGA1700 socket 13th/12th Gen Intel® Core™ i9/i7/i5/i3 or Celeron® processor, Intel® R680E, 2 HDMI, DisplayPort, 6 USB, 4 LAN, and 9 to 36 VDC
--	--

This page is intentionally left blank.

SECTION 2 HARDWARE INSTALLATION

The is convenient for various hardware configurations, such as CPU, DRAM, HDD (Hard Disk Drive), SSD (Solid State Drive), PCI Express Mini card modules and optional MXM graphic module. Section 2 contains guidelines for hardware installation.

2.1 Installation of CPU

- Step 1** Turn off the system and unplug the power cord.
- Step 2** Loosen four screws of the top heatsink & two screws of the front/rear panel.
- Step 3** Remove the top heatsink.

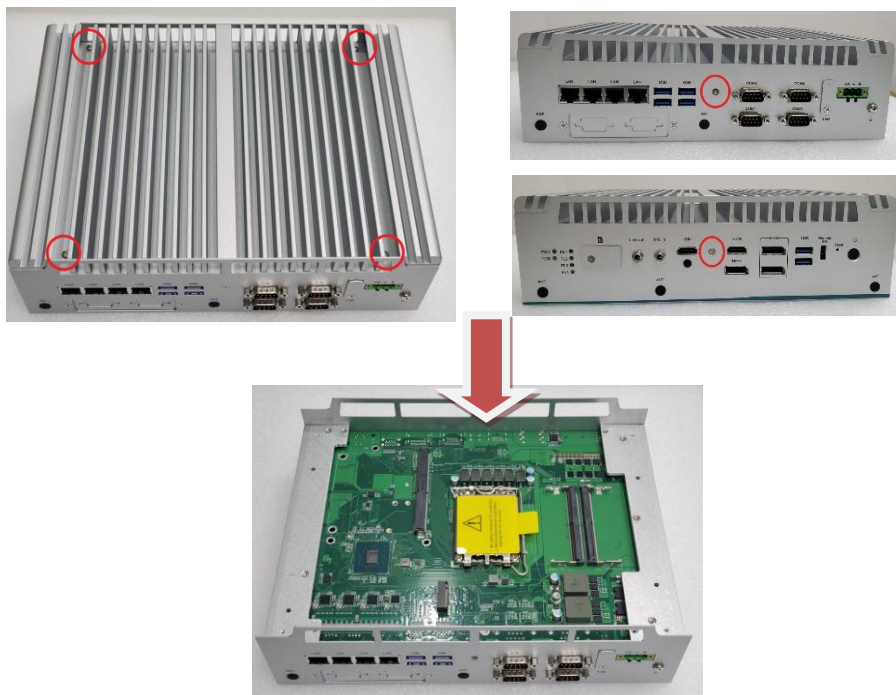

Step 4 Remove the warning label and disengage load lever.

- Disengage load lever by pushing its hook down and then pulling it slightly outward.
- Rotate load lever to open position at approximately 135°.
- Rotate load plate to open position at approximately 150°.



Note

Apply pressure to corner with right-hand thumb when opening or closing load lever - otherwise lever will bounce back (as a mouse trap) causing bent contacts.

Step 5 CPU installation steps:

- Lift processor package from shipping media by grasping the substrate edges.



- Scan the processor package gold pads for any presence of foreign material.
- Locate connection 1 indicator on the processor which aligns with connection 1 indicator chamfer on the socket, and notice processor keying features that line up with posts along socket walls.
- Grasp the processor with thumb and index finger along the top and bottom edges. The socket will have cutouts for your fingers to fit into.
- Carefully place the processor into the socket body vertically.

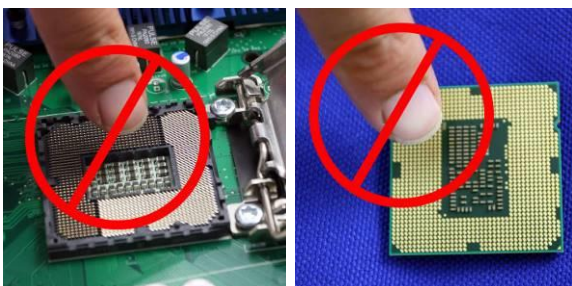
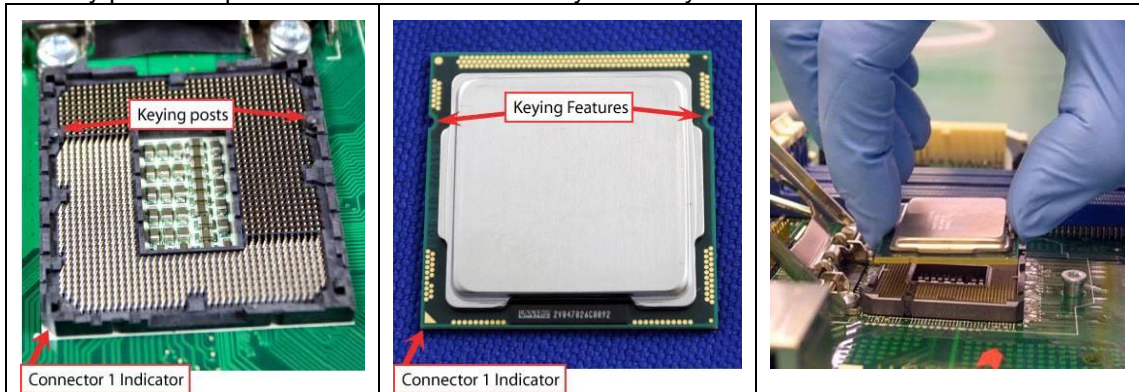

Never touch fragile socket contacts to avoid damage and do not touch the processors sensitive contacts at any time during installation.

- Step 6** Align pins of the CPU with pin holes of the socket. While installing the CPU, pay attention to the CPU's orientation by aligning the arrow mark on the CPU with the arrow key on the socket.

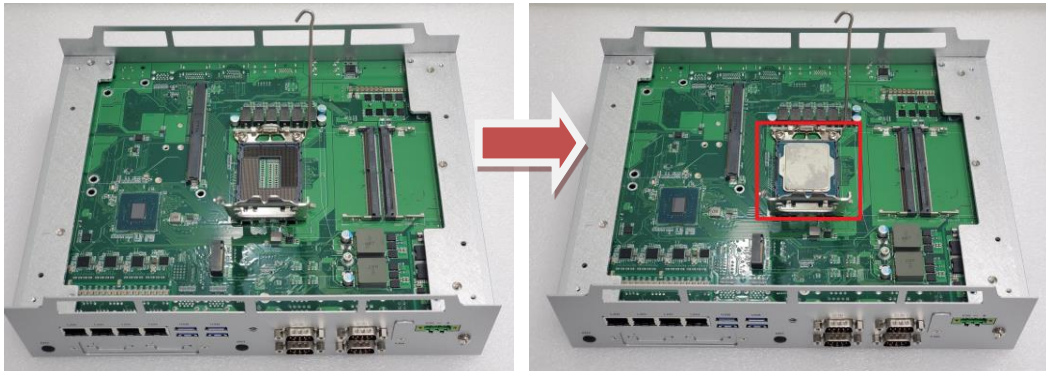

- Step 7** Put the top cover and fasten four screws of the top cover and two screws of the front/rear panel back onto the system.

2.2 Installation of DRAM Module

- Step 1** Turn off the system and unplug the power cord.
Step 2 Loosen four screws of the top heatsink & two screws of the front/rear panel.
Step 3 Remove the top heatsink and located the dual SO-DIMM socket.

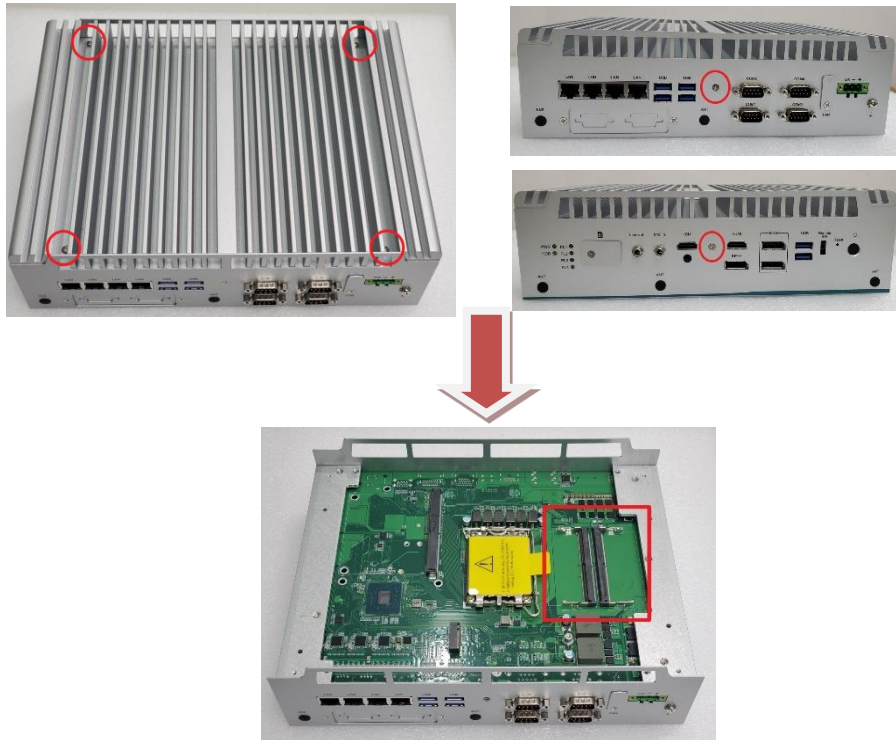

- Step 4** Prepare thermal pad, the system will come with 2pcs thermal pad in accessory pack. The thermal pads will come with plastic liner on one side, so make sure it is removed before use. And then stick the thermal pad on the DRAM socket.

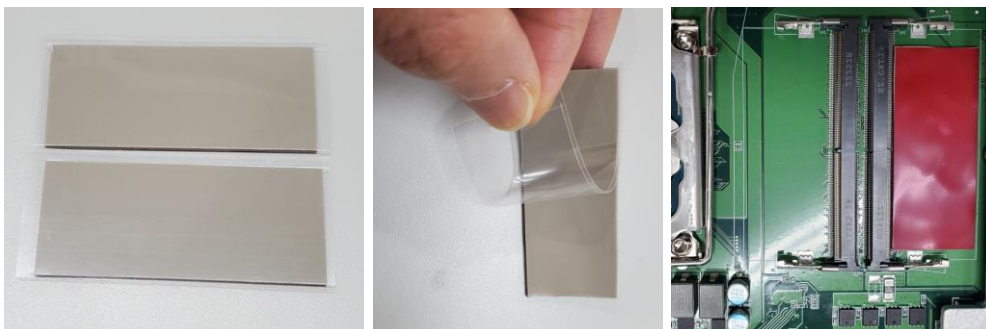

- Step 5** Use a pair of tweezers to peel one side of protective film away from the remaining thermal pad and hold the edge of the DRAM and insert it into the DRAM notch at an angle of approximately 30 degrees, and then gently press it down until the latches are buckled.

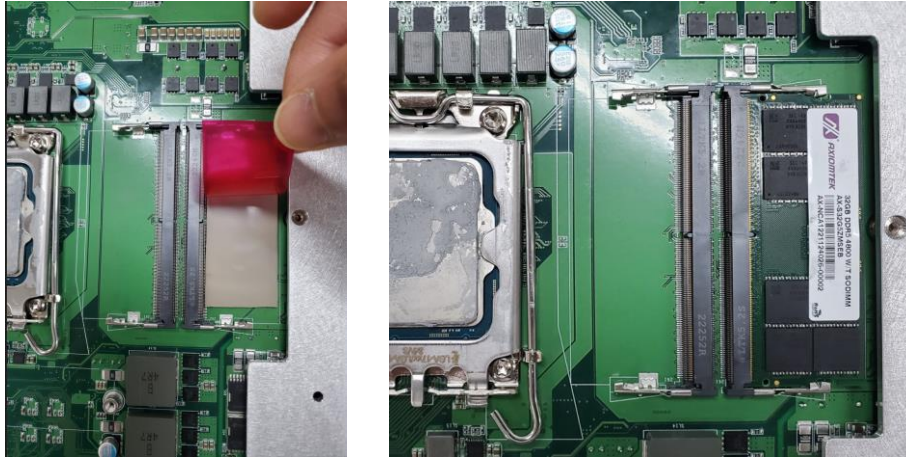

- Step 6** Put the top cover and fasten four screws of the top cover and two screws of the front/rear panel back onto the system.

2.3 Installation of 2.5" SATA Device

Step 1 Turn off the system and unplug the power cord.

Step 2 Loosen three screws to remove bottom cover and locate two SSD/HDD within the red line as marked.

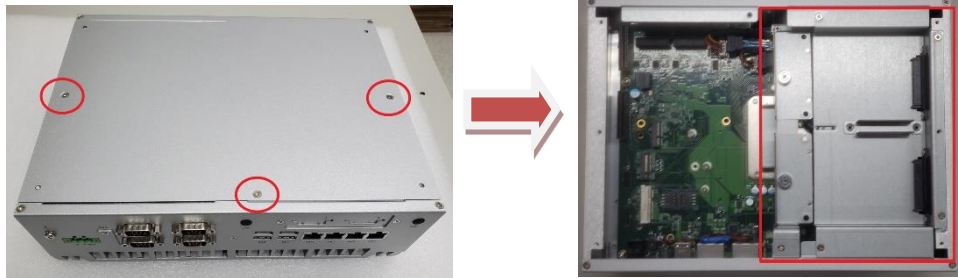

Step 3 Assembly each SSD/HDD with the HDD bracket with 2 screws.

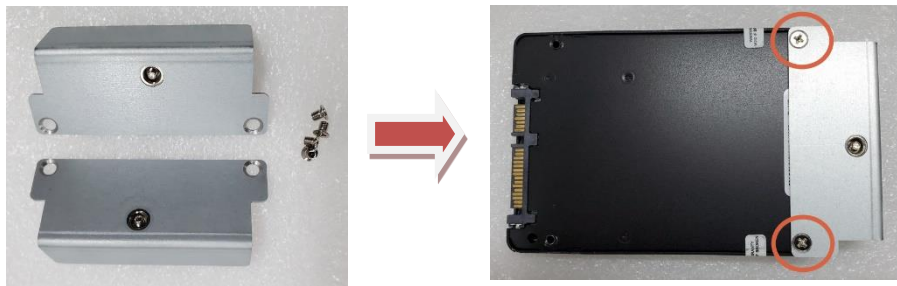

Step 4 Push the SATA drive tray to insert the connector firmly and fasten the screw to make sure the insertion is complete.

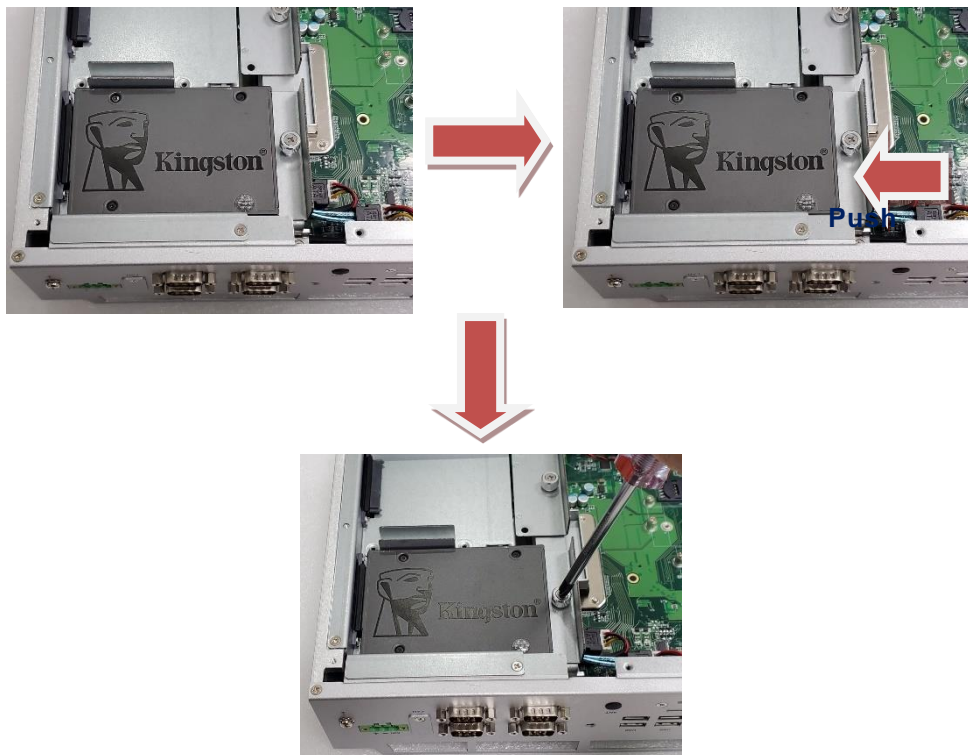

2.4 Installation of M.2 Key B Mini PCIe Module (CN20)

The [device] is equipped with an M.2 Key B 3052 socket for users to install an 5G module.

Step 1 Turn off the system and unplug the power cord.

Step 2 Loosen three screws to remove bottom cover and locate M.2 key B mini card slot within the red line as marked.

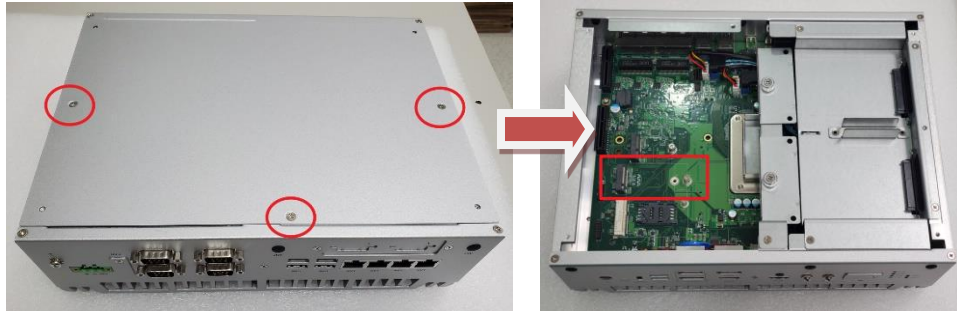

Step 3 Insert 5G wireless module into the slot and tighten the card securely to the mainboard with M3x3 screw, and attach the IPEX-to-SMA cable to the 5G module.

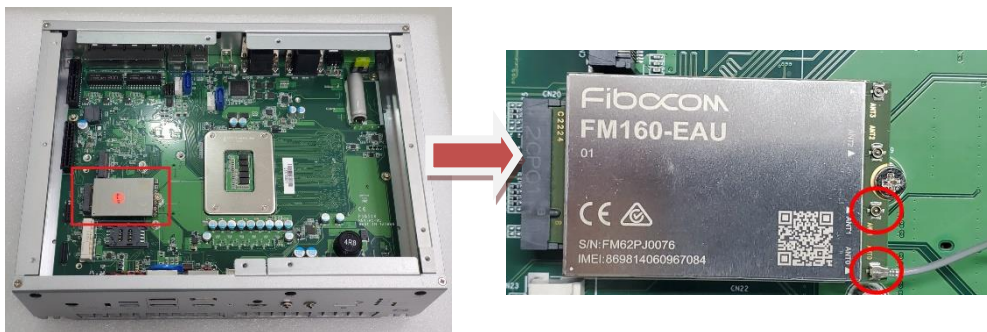

Step 4 Remove the front panel-accessible SIM socket cover and insert the SIM card upside down to the SIM socket to support wireless communication.

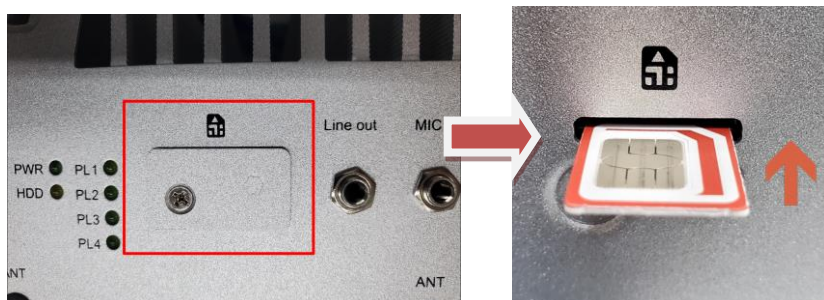

Step 5 Remove the antenna cover from system, fix the SMA connector of the IPEX-to-SMA cable to one of the five antenna apertures on either front panel of back panel.

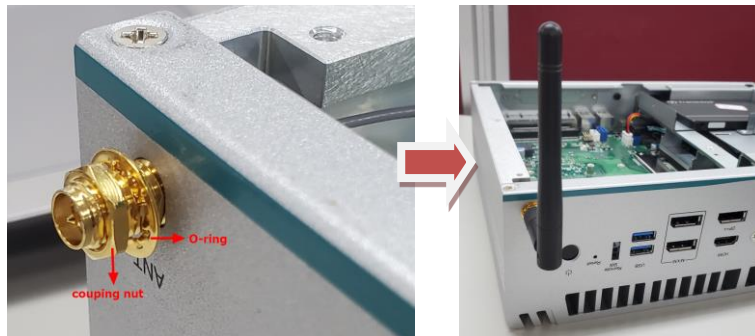

Step 6 Put the bottom cover and fasten all screws back onto the system.



Note: The thermal solution might be changed due to the different 5G module installed.



Note: There are five antenna holes on the system, please adjust the antenna placement accordingly



2.5 Installation of Mini PCIe Module (CN23)

provides one full-size mini-PCIe socket with SIM card support. Customers can use this socket for install wireless modules or flexible IO modules to expand functions

Install Mini PCIe Modules, please follow the instructions as blow:

- 1 x GbE Kit (RJ45*1)
- 1 x CAN Bus (DB9*1)
- 2 x RS-232 Kit (DB9*2, via flat cable)
- 2 x GbE Kit (RJ45*1)



Note: Please reference the data sheet for more mini card modules model.

Step 1 Prepare the optional mini PCIe module kit as below photo shows.

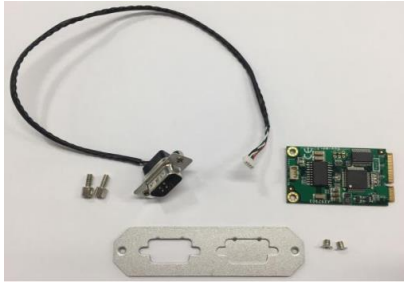

Step 2 Turn off the system and unplug the power cord.

Step 3 Loosen three screws to remove bottom cover and locate PCIe mini card slot within the red line as marked.

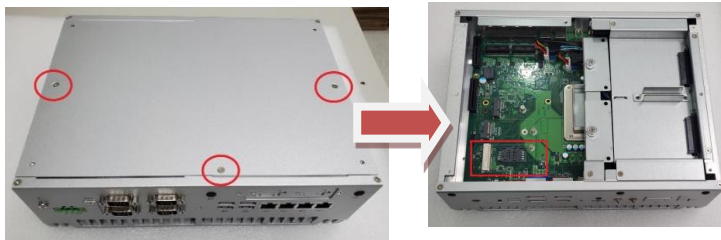

Step 4 Insert a mini PCIe module into the socket and tighten the card securely to the mainboard with one M3x2 screw.



Step 5 Connect the cable to the module and assemble I/O connector to fix the I/O bracket then fasten dual screws of the Flexible I/O Window.

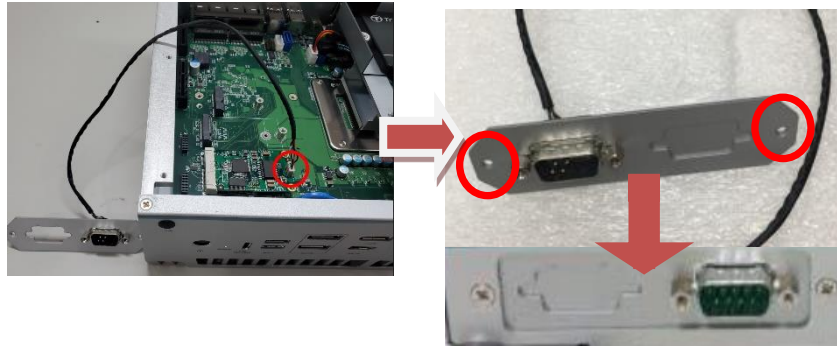

Step 6 Put the bottom cover and fasten all screws back onto the system.

Install LTE Mini PCIe Modules, please follow the instructions as blow:

Step 1 Turn off the system and unplug the power cord.

Step 2 Loosen three screws to remove bottom cover and locate PCIe mini card slot within the red line as marked.

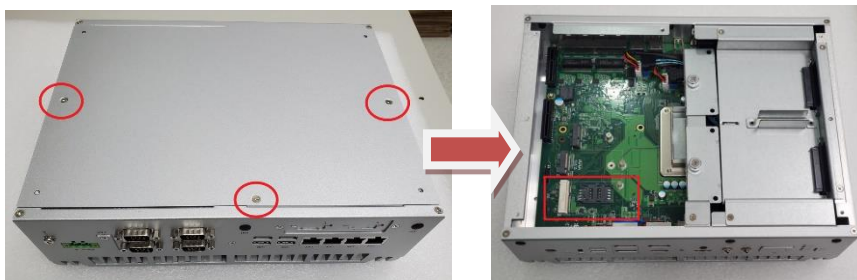

Step 3 Insert the corresponding SIM card into SIM socket (CN22) before you install the mini-PCIe module.

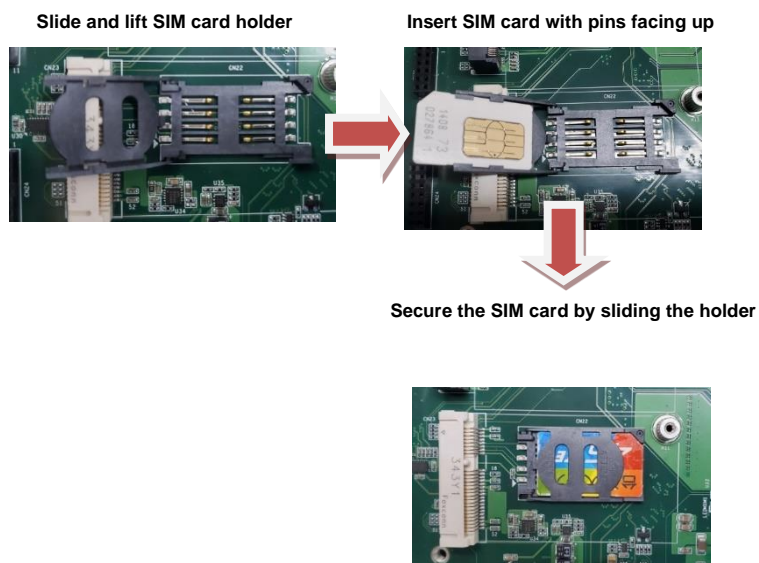



Step 4 Insert the LTE mPCIe module on a 45 degree angle into the mPCIe slot and secure the module with M3x2 screw.

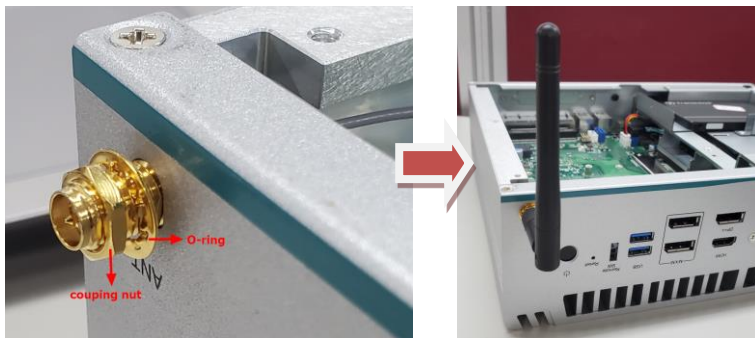

Step 5 Remove the antenna cover from system, fix the SMA connector of the IPEX-to-SMA cable to one of the five antenna apertures on either front panel of back panel.



 *Note: Please use an extended bracket when using a half-size Mini card*

 *Note: If users install Wi-Fi module, the installation procedure is the same as with LTE module, but there is no need to insert a sim card.*

 *Note: There are five antenna holes in the system, please adjust the antenna placement according to the environment.*



2.6 Installation of M.2 Key E Mini PCIe Module (CN19)

The [device] is equipped with an M.2 Key E 2230 socket for users to install an Wi-Fi 6E wireless module.

- Step 1** Turn off the system and unplug the power cord.
Step 2 Loosen three screws to remove bottom cover and locate M.2 key E mini card slot within the red line as marked.

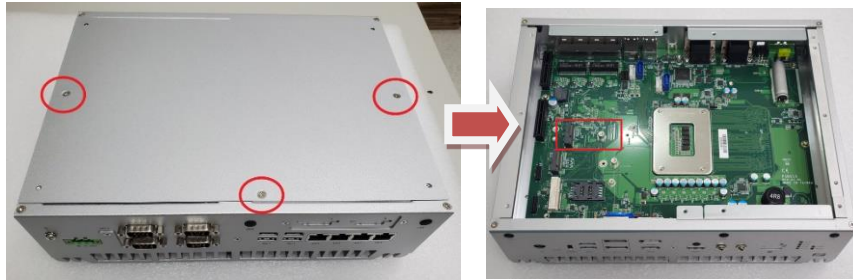

- Step 3** Insert Wi-Fi 6E wireless module into the slot and tighten the card securely to the mainboard with M3x3 screw.

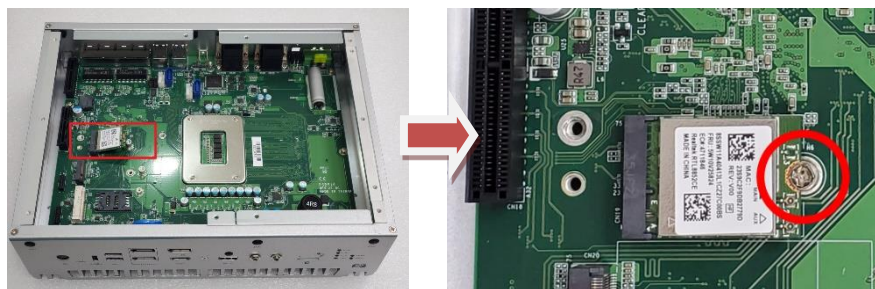

- Step 4** Attach the corresponding IPEX-to-SMA cable (2pcs) to the module as below red marked.

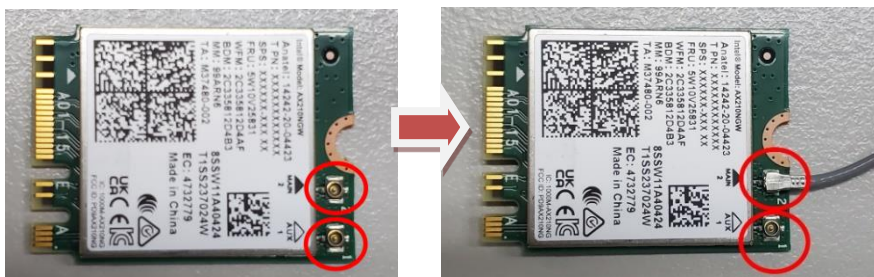

Step 5 Remove the antenna cover from system, fix the SMA connector of the IPEX-to-SMA cable to one of the five antenna apertures on either front panel of back panel.

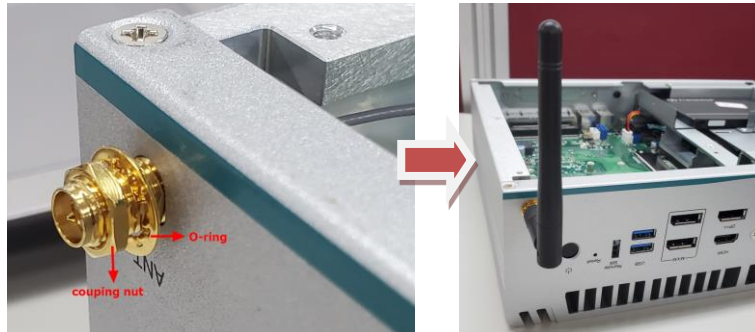

Step 6 Put the bottom cover and fasten all screws back onto the system.



Note: There are five antenna holes on the system, please adjust the antenna placement accordingly



2.7 Installation of Optional MXM Graphic Module (SCN4)

The _____, equipped with a MXM 3.1 type A slot for users to install a fan-less GPU module.

- Step 1** Turn off the system and unplug the power cord.
- Step 2** Loosen four screws of the top heatsink & two screws of the front/rear panel.
- Step 3** Remove the top heatsink.

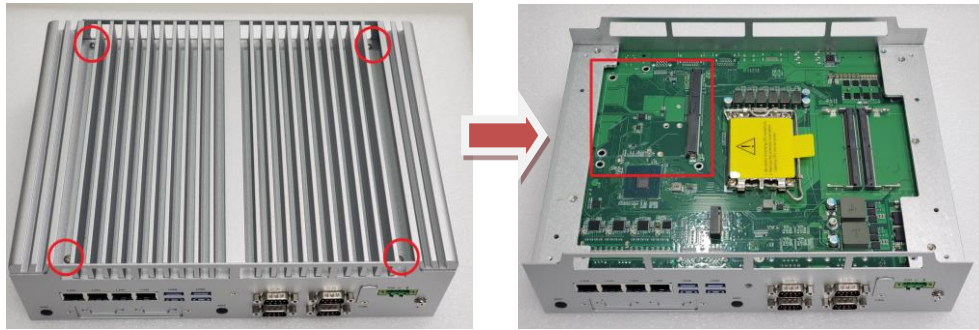

- Step 4** Insert optional NVIDIA®/AMD® MXM module kit into the connector and fasten two screws.

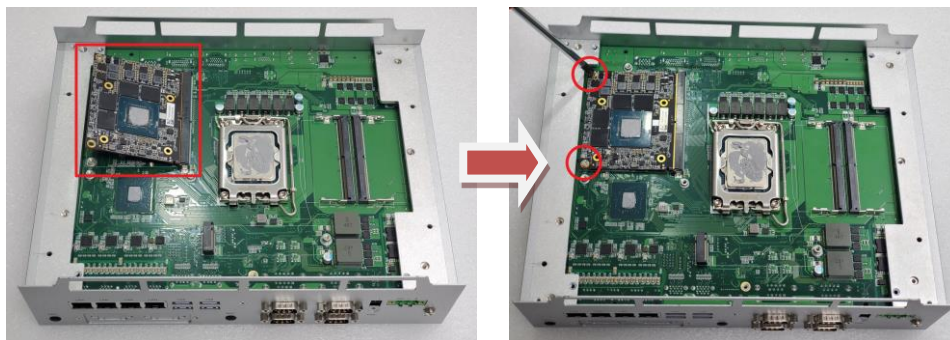

- Step 5** Prepare the optional heat spreader (comes with MXM T1000 module kit) and put the grease as below red marked on the bottom side of the copper heat spreader.

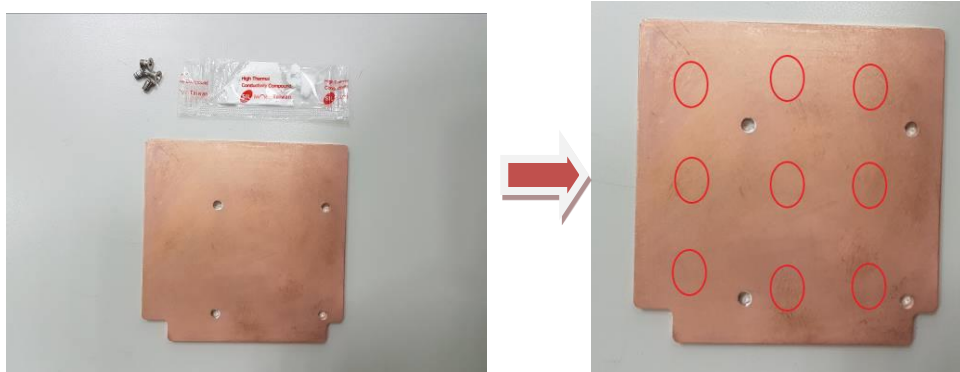

Step 6 Fasten the copper thermal pad onto the top heat sink, and please make sure that the notch as red marked is facing up.

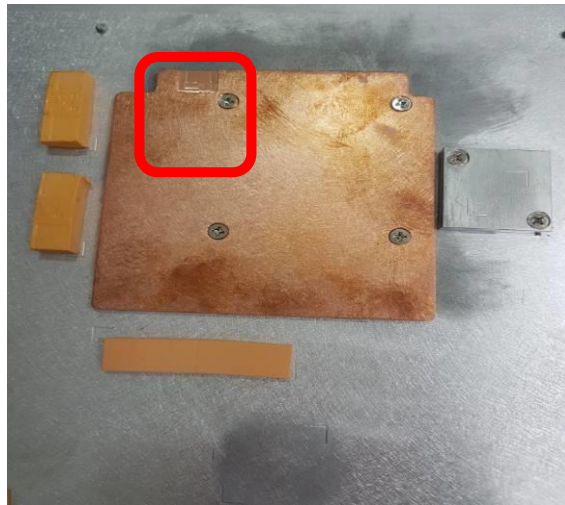

Step 7 Fasten the top cover back to complete the MXM module installation.



Note: The thermal solution might be changed due to the different MXM module installed, please find more information on product data sheet.

2.8 Installation of NVMe SSD Module (SCN1)

The [redacted] is equipped with an M.2 Key M 2280 socket (PCIex4 signal) for users to install an NVMe SSD module. Please refer to the following instructions and illustrations for the installation of the NVMe SSD module.

Step 1 Turn off the system and unplug the power cord.

Step 2 Loosen four screws of the top heatsink & two screws of the front/rear panel.

Step 3 Remove the top heatsink.

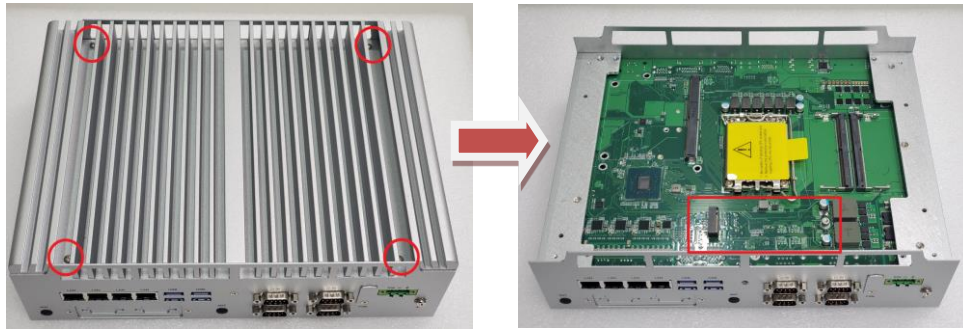

Step 4 Insert M.2 NVMe module into the slot and tighten the screw.

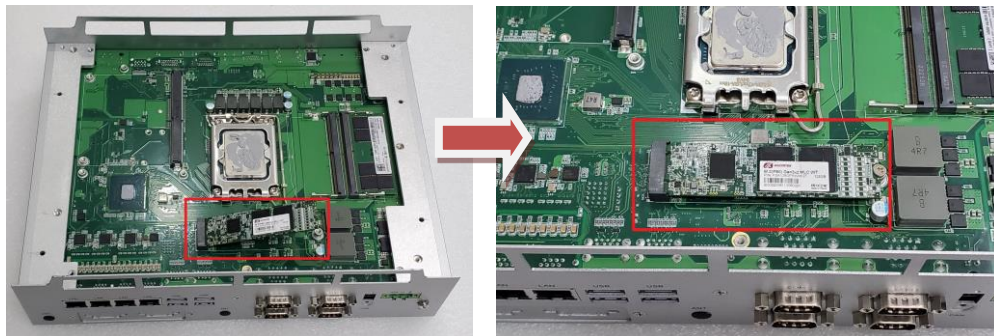

Step 5 Put the top cover and fasten all screws back onto the system.

2.9 Installation of External FAN kit (CN2)

The supports optional FAN kit for MXM module if users need better operation temperature, please follow the following instruction to install the FAN kit.

The is designed with an optional external fan kit to enhance GPU computing performance and extend the operating temperature range. CN25 serves as the fan connector, making it easy and effortless for users to install and maintain the external fan kit

Step 1 Prepare the FAN kit module.

Step 2 Turn off the system and unplug the power cord.



Step 3 Assemble the fan kit bracket on both side of the system first and then secure four screws as red marked.

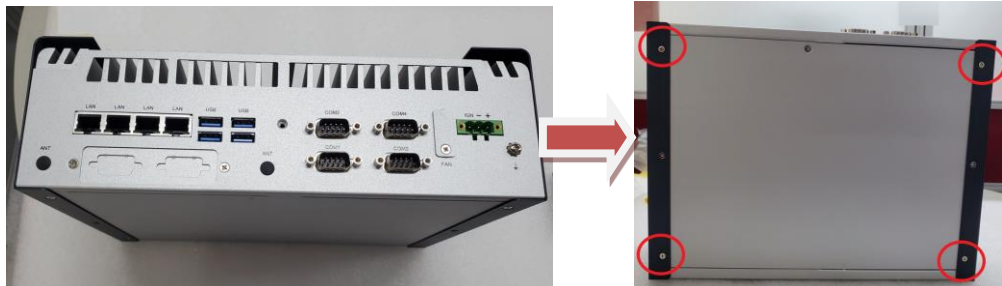

Step 4 Put the FAN kit top cover and fasten 4pcs screws.

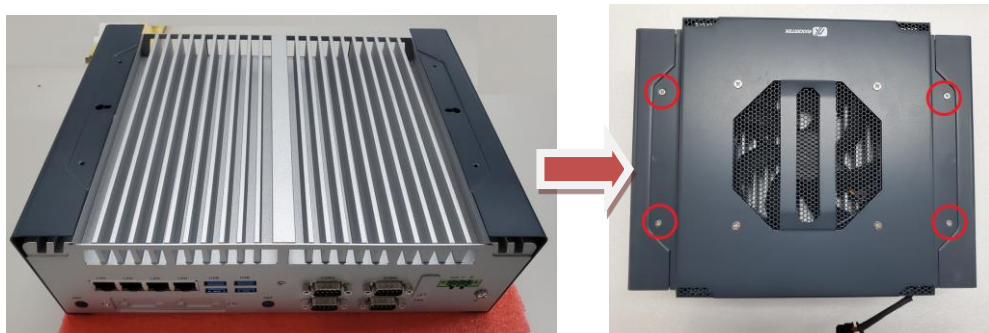

Step 5 remove the FAN connector cover.

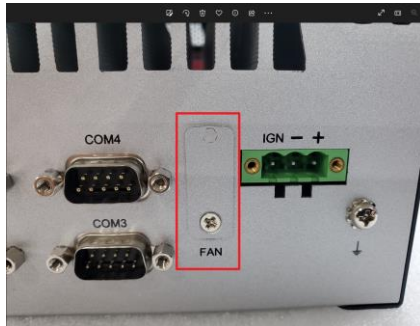

Step 6 Connector the fan cable to the fan connector of the system and put the cover back.

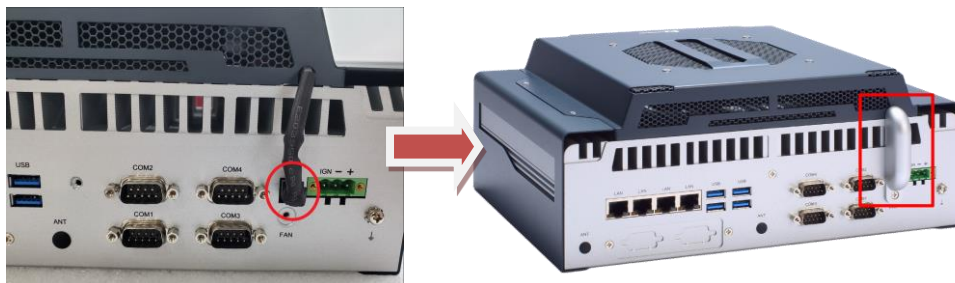

This page is intentionally left blank.

SECTION 3 JUMPER & CONNECTOR SETTINGS

Proper jumper settings configure the to meet various application needs.-Hereby all jumpers settings along with their default settings are listed for devices onboard.

3.1 Locations of Jumpers & Connectors

PSB503 Top View

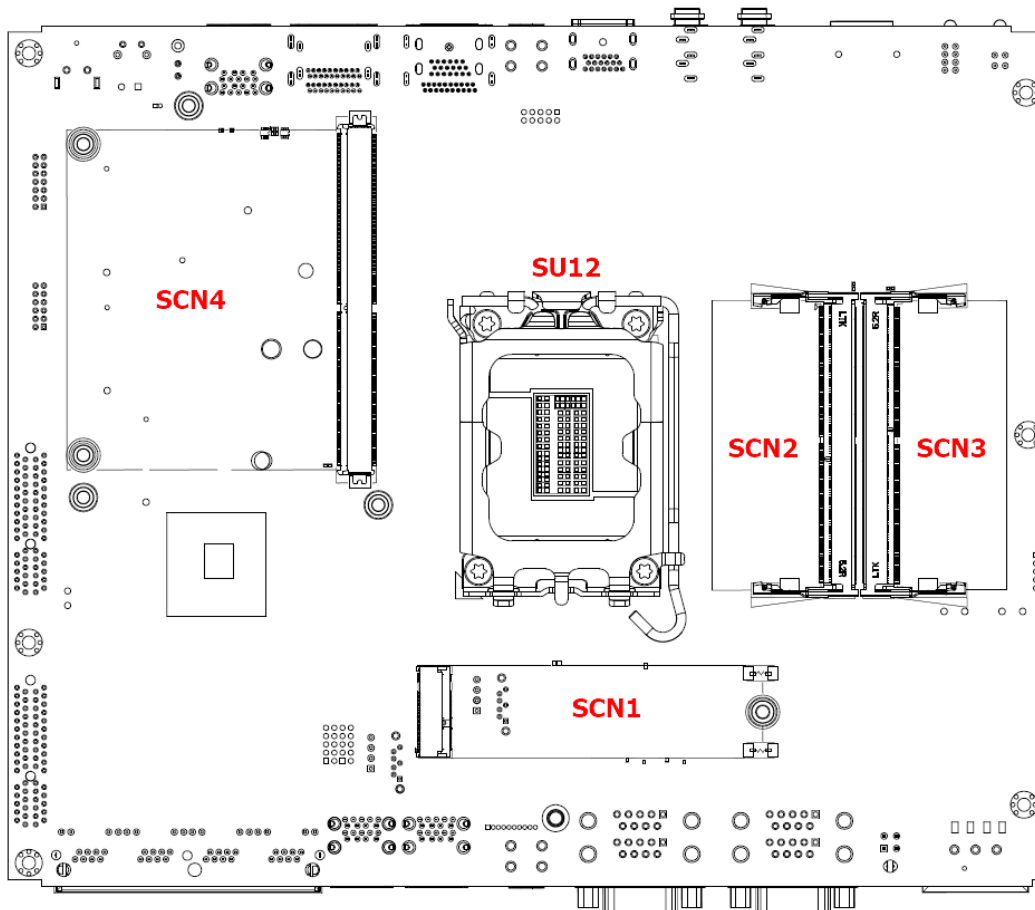

PSB503 Bottom View

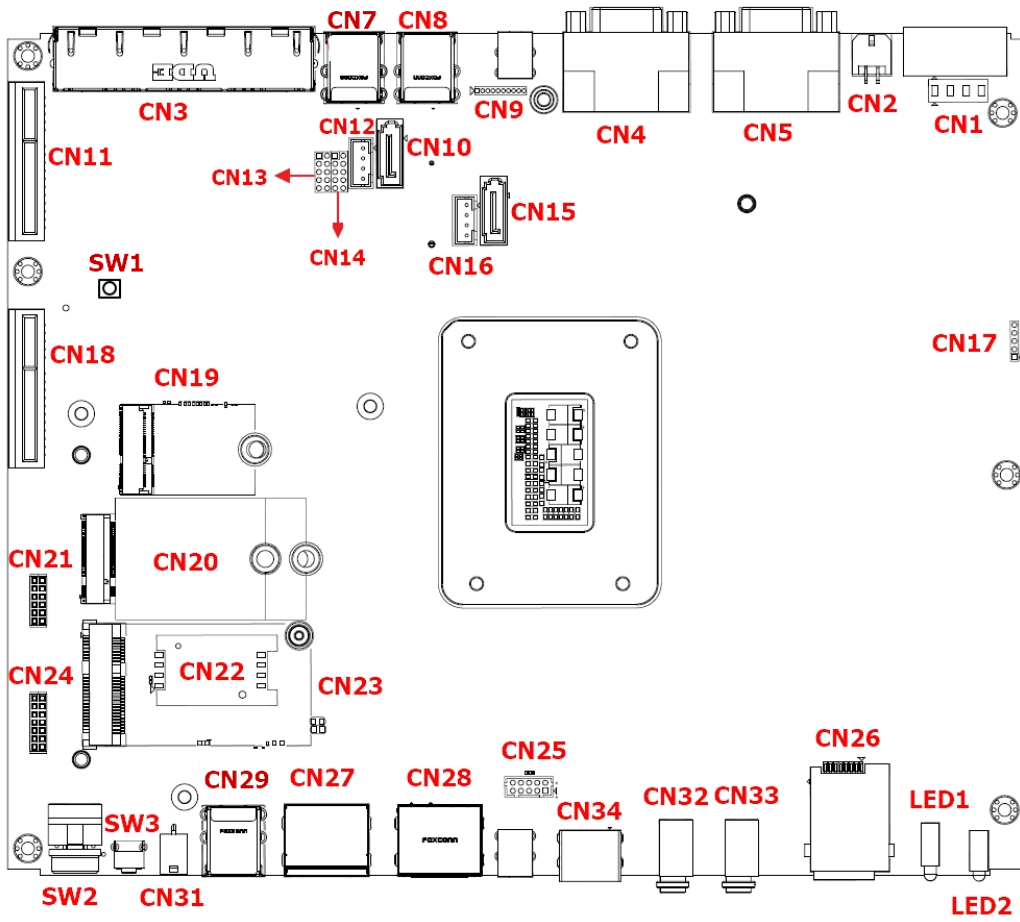

3.2 Summary of Jumper Settings

Proper jumper settings configure the to meet various application purposes. A table of all jumpers and their default settings is listed below.



【Note】 : How to setup Jumpers

That a cap on a jumper is to “close” the jumper, whereas that offs a jumper is to “open” the jumper.



[Open]



[Closed]



[Pin1-2 Closed]

3.2.1 Clear CMOS (SW1)

Use the switch SW1 to for clear CMOS.

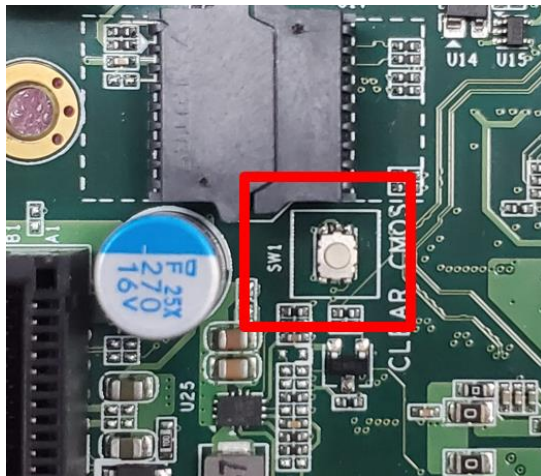

3.3 Connectors

Please refer to below connector table to get their pin assignments.

External Connectors	Sections
DC-in Phoenix Power Connector (CN1)	3.3.1
HDMI Connector (CN28, CN34)	3.3.2
DisplayPort Connector (CN28)	3.3.3
Serial Port Connector (CN4, CN5)	3.3.4
USB 3.2 Connector (CN29, CN8, CN7)	3.3.5
Ethernet Connector (LAN 1~ LAN 4)	3.3.6
ATX Power On/Off Button (SW2)	3.3.7
Reset Button (SW3)	3.3.8
Remote Power Switch Connector (CN31)	3.3.9
Optional FAN connector (CN2)	3.3.10
Internal Connectors	Sections
SATA Signal Connector (CN10, CN15)	3.3.11
SATA Power Connector (CN12, CN16)	3.3.12
SIM Slot (CN22, CN26)	3.3.13
Full-Size Express Mini Card slot (CN23)	3.3.14
M.2 Key B (CN20)	3.3.15
M.2 Key E (CN19)	3.3.16
M.2 Key M (SCN1)	3.3.17
Optional Audio (CN32, CN33)	3.3.18
Optional 8CH Digital IO (onboard) (CN13, CN14)	3.3.19

3.3.1 DC-in Phoenix Power Connector (CN1)

The system supports 9~48V Phoenix DC-in connector for system power input.

Pins	Signals
1	DC+
2	DC-
3	ACC

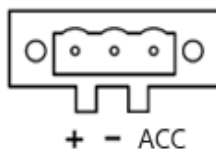

3.3.2 HDMI Connector (CN28, CN34)

The HDMI (High-Definition Multimedia Interface) is a compact digital interface which is capable of transmitting high-definition video and high-resolution audio over a single cable.

Pins	Signals	Pins	Signals
1	HDMI OUT_DATA2+	11	GND
2	GND	12	HDMI OUT Clock-
3	HDMI OUT_DATA2-	13	N.C.
4	HDMI OUT_DATA1+	14	N.C.
5	GND	15	HDMI OUT_SCL
6	HDMI OUT_DATA1-	16	HDMI OUT_SDA
7	HDMI OUT_DATA0+	17	GND
8	GND	18	+5V
9	HDMI OUT_DATA0-	19	HDMI_HTPLG
10	HDMI OUT Clock+		

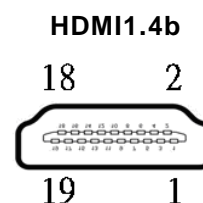

3.3.3 DisplayPort++ 1.2a Connector (CN28)

supports one DisplayPort outputs.

Pins	Signals	Pins	Signals
1	DPB_LANE0	11	GND
2	GND	12	DPB_LANE3#
3	DPB_LANE0#	13	Detect Pin
4	DPB_LANE1	14	GND
5	GND	15	DPB_AUX
6	DPB_LANE1#	16	GND
7	DPB_LANE2	17	DPB_AUX#
8	GND	18	DPB_HPDE
9	DPB_LANE2#	19	GND
10	DPB_LANE3	20	+3.3V

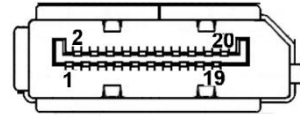

3.3.4 DisplayPort Connector (CN27)(optional, via MXM module)

support optional two DisplayPort outputs via MXM module.

Pins	Signals	Pins	Signals
1	DPB_LANE0	11	GND
2	GND	12	DPB_LANE3#
3	DPB_LANE0#	13	Detect Pin
4	DPB_LANE1	14	GND
5	GND	15	DPB_AUX
6	DPB_LANE1#	16	GND
7	DPB_LANE2	17	DPB_AUX#
8	GND	18	DPB_HPDE
9	DPB_LANE2#	19	GND
10	DPB_LANE3	20	+3.3V

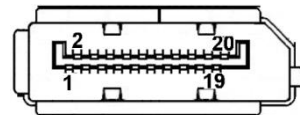

3.3.5 Serial Port Connector (CN4,CN5)

The system has two serial ports. COM1~COM2 are RS-232/422/485 ports. COM3~COM4 are RS-232 Please refer to Chapter 4 for the detail of BIOS setting.

Baud rate support up to 115200

Pins	RS-232	RS-422	RS-485
1	DCD, Data Carrier Detect	TX-	Data-
2	RXD, Receive Data	TX+	Data+
3	TXD, Transmit Data	RX+	No use
4	DTR, Data Terminal Ready	RX-	No use
5	GND, Ground	No use	No use
6	DSR, Data Set Ready	No use	No use
7	RTS, Request To Send	No use	No use
8	CTS, Clear To Send	No use	No use
9	RI, Ring Indicator	No use	No use

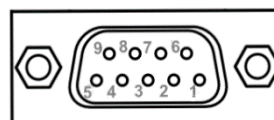

3.3.6 USB 3.2 Connector (CN29, CN8, CN7)

The system has six USB port, six port compliant with USB 3.2 gen2 (10GB/s), and ideally for installing USB peripherals such as scanner, camera, and USB devices, etc.

Pins	Signal USB Port 0	Pins	Signal USB Port 1
1	USB_VCC (+5V level standby power)	10	USB_VCC (+5V level standby power)
2	USB_Data-	11	USB_Data-
3	USB_Data+	12	USB_Data+
4	GND	13	GND
5	SSRX-	14	SSRX-
6	SSRX+	15	SSRX+
7	GND	16	GND
8	SSTX-	17	SSTX-
9	SSTX+	18	SSTX+

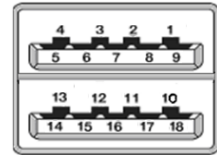

3.3.7 Ethernet Connector (LAN1~LAN4)

The board has four RJ-45 Gbe ports connectors, one LAN port is designed by Intel i219-LM and three LAN ports are Intel i226-IT.

Pins	LAN Signal	Pins	LAN Signal
L1	MDI0+	L5	MDI2+
L2	MDI0-	L6	MDI2-
L3	MDI1+	L7	MDI3+
L4	MDI1-	L8	MDI3-
A	Activity link LED(Yellow) OFF: No link Blinking: Link established; data activity detected		
B	Speed LED OFF: 10Mbps data rate Green: 100Mbps data rate Orange: 1Gbps data rate		

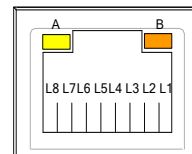

3.3.8 ATX Power On/Off (SW2)

The ATX power button is on the I/O side. It can allow users to control power on/off.

Functions	Descriptions
On	Turn on/off system
Off	Keep system status



3.3.9 Reset Switch (SW3)

The Reset button can allow users to reset system.

Functions	Descriptions
On	Reset system
Off	Keep system status



3.3.10 Remote Power Switch Connector (CN31)

One 2-pin connector output for remote power on/off switch.

Functions	Descriptions
Short(1-2)	Turn on/off system
Open	Keep system status

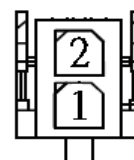

3.3.11 FAN Kit Connector (CN2)(optional)

One 4pin connector output for optional Fan.

Functions	Descriptions
1	FANIN_CPU
2	GND
3	+12V
4	FANOUT_CPU

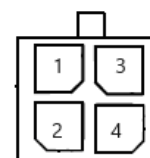

3.3.12 SATA Connector (CN10 & CN15)

These Serial Advanced Technology Attachment (Serial ATA or SATA) connectors are for high-speed SATA interfaces. They are computer bus interfaces for connecting to devices such as hard disk drives. This board has two SATA 3.0 ports with 6Gb/s performance.

Pins	Signals
1	GND
2	SATA_TX+
3	SATA_TX-
4	GND
5	SATA_RX-
6	SATA_RX+
7	GND

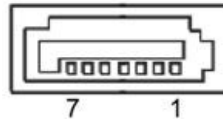

3.3.13 SATA Power Connector (CN12,CN16)

Based on CN12 · CN16 to offer the SATA power for SATA 2.5" HDD/SSD.

Pins	Signals
1	+12V level
2	GND
3	GND
4	+5V level

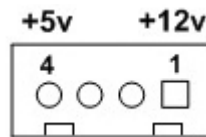

3.3.14 SIM Card Slots (CN22, CN26)

The includes two SIM slots: CN22 on bottom side that support mini PCIe slot (for CN23), CN26 on top side of the system that support M.2 Key B (for CN20), It is mainly used in wireless network application on CN22 and CN26.

Pins	Signals
1	PWR
2	RST
3	CLK
4	NC
5	GND
6	VPP
7	I/O
8	NC

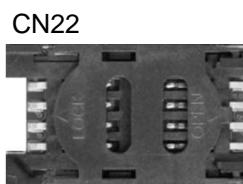
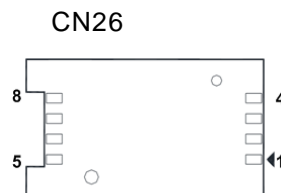

3.3.15 Full-Size PCI Express Mini Card Slot (CN23)

The _____ supports one full-size PCI-Express Mini Card slot.

CN23 is applying for PCI-Express or SATA (mSATA) via BIOS selection and USB signals; PCI-Express complies with PCI-Express Mini Card Spec. V1.2. Thus, users can install mSATA or WLAN/WWAN cards into this slot. Please refer to the SATA of BIOS setting to enable or disable mSATA supported.

Pins	Signals	Pins	Signals
1	WAKE#	2	+3.3VSB
3	No use	4	GND
5	No use	6	+1.5V
7	CLKREQ#	8	No use
9	GND	10	No use
11	REFCLK-	12	No use
13	REFCLK+	14	No use
15	GND	16	No use
17	No use	18	GND
19	No use	20	W_DISABLE#
21	GND	22	PERST#
23	PE_RXN3/	24	+3.3VSB
25	PE_RXP3/	26	GND
27	GND	28	+1.5V
29	GND	30	SMB_CLK
31	PE_TXN3/	32	SMB_DATA
33	PE_TXP3/	34	GND
35	GND	36	USB_D8-
37	GND	38	USB_D8+
39	+3.3VSB	40	GND
41	+3.3VSB	42	No use
43	GND	44	No use
45	No use	46	No use
47	No use	48	+1.5V
49	No use	50	GND
51	No use	52	+3.3VSB

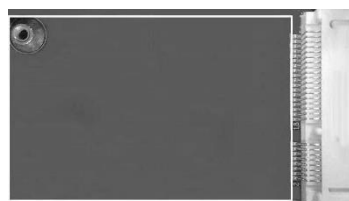
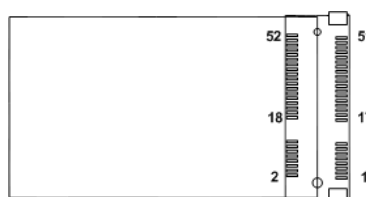

3.3.16 M.2 3052 Key B slot (CN20)

The M.2 3052 Key B for 5G Module.

Pin	Signal	Pin	Signal	Pin	Signal	Pin	Signal
1	NC	2	+3.3V	3	GND	4	+3.3V
5	GND	6	NC	7	USB_D+	8	NC
9	USB_D-	10	SATA_LED	11	GND	12	Key B
13	Key B	14	Key B	15	Key B	16	Key B
17	Key B	18	Key B	19	Key B	20	NC
21	NC	22	NC	23	NC	24	NC
25	NC	26	NC	27	GND	28	NC
29	USB3.1-Tx-	30	UIM-RESET	31	USB3.1-Tx+	32	UIM-CLK (O)
33	GND	34	UIM-DATA (I/O)	35	USB3.1-Rx-	36	UIM-PWR (O)
37	USB3.1-Rx+	38	NC	39	GND	40	NC
41	PERn0	42	NC	43	PERp0	44	NC
45	GND	46	NC	47	PETn0	48	NC
49	PETp0	50	PERST#	51	GND	52	CLKREQ#
53	REFCLKn	54	PEWAKE#	55	REFCLKp	56	NC
57	GND	58	NC	59	NC	60	NC
61	NC	62	NC	63	NC	64	NC
65	NC	66	NC	67	RESET# (I)(0/1.8V)	68	NC
69	NC	70	+3.3V	71	GND	72	+3.3V
73	GND	74	+3.3V	75	NC		

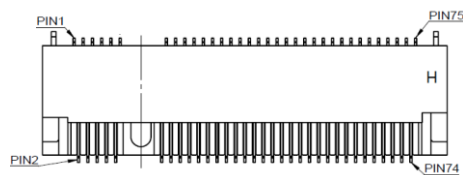

3.3.17 M.2 2230 Key E slot (CN19)

The system comes with one M.2 Key E socket (PCIe & USB2.0)

Pins	Signals	Pins	Signals
1	GND	2	+3.3V_SBY
3	USB_D+	4	+3.3V_SBY
5	USB_D-	6	NC
7	GND	8	M.2_BT_PCMCLK
9	CNVI_WGR_DATA1_D-	10	M.2_BT_PCMRST
11	CNVI_WGR_DATA1_D+	12	M.2_BT_PCMIN
13	GND	14	M.2_BT_PCMIOUT
15	CNVI_WGR_DATA0_D-	16	NC
17	CNVI_WGR_DATA0_D+	18	GND
19	GND	20	UART_BT_WAKE-
21	CNVI_WGR_CLK_D-	22	CNVI_BRI_RSP
23	CNVI_WGR_CLK_D+	24	Key E
25	Key E	26	
27		28	
29		30	
31		32	
33		GND	34
35	PCIE_TX_+	36	CNVI_BRI_DT
37	PCIE_TX_-	38	CL_RST
39	GND	40	CL_DATA
41	PCIE_RX_+	42	CL_CLK
43	PCIE_RX_-	44	CNVI_GNSS_PA_BLANKING
45	GND	46	CNVI_MFUART_TXD
47	CLK_PCIE_+	48	CNVI_MFUART_RXD
49	CLK_PCIE_-	50	SUSCLK (+3.3V Level)
51	GND	52	PERST# (+3.3V Level)
53	CLKREQ0#	54	BT_RF_KILL
55	PEWAKE0#	56	WIFI_RF_KILL
57	GND	58	NC
59	CNVI_WT_DATA1_D-	60	NC
61	CNVI_WT_DATA1_D+	62	NC
63	GND	64	GND
65	CNVI_WT_DATA0_D-	66	NC

67	CNVI_WT_DATA0_D+	68	NC
69	GND	70	NC
71	CNVI_WT_CLK_D-	72	+3.3V_SBY
73	CNVI_WT_CLK_D+	74	+3.3V_SBY
75	GND		

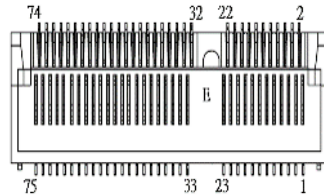

3.3.18 M.2 2230 Key M slot (SCN1)

The system comes with one M.2 Key E socket (PCIe & USB2.0)

3.3.19 HD Audio Digital Header (CN32, CN33)

This audio jack support for Audio Mic-In and Line-out.

Pin	Signal
1	Line Out
2	Microphone In

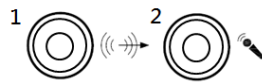

3.3.20 Digital I/O (CN13 and CN14) (optional)

The system is equipped with 16bit programmable Digital I/O, please refer to the following table to get default pin define. Default is 4in/4out.

The digital I/O can be configured to control cash drawers and sense warning signals from an Uninterrupted Power System (UPS) or perform store security control. You may use software programming to control these digital signals.

CN14

Pins	Signals	Pins	Signals
1	DIO1_IN	2	DIO8_OUT
3	DIO2_IN	4	DIO7_OUT
5	DIO3_IN	6	DIO6_OUT
7	DIO4_IN	8	DIO5_OUT
9	+5V	10	GND

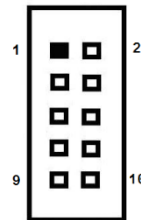

CN13

Pins	Signals	Pins	Signals
1	DIO9_IN	2	DIO16_OUT
3	DIO10_IN	4	DIO15_OUT
5	DIO11_IN	6	DIO14_OUT
7	DIO12_IN	8	DIO13_OUT
9	+5V	10	GND

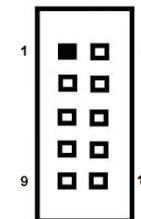

This page is intentionally left blank.

SECTION 4

BIOS SETUP UTILITY

This section provides users with detailed descriptions in terms of how to set up basic system configurations through the BIOS setup utility.

4.1 Starting

To enter the setup screens, follow the steps below:

1. Turn on the computer and press the key immediately.
2. After press the key, the main BIOS setup menu displays. Users can access to other setup screens, such as the Advanced and Chipset menus, from the main BIOS setup menu.

It is strongly recommended that users should avoid changing the chipset's defaults. Both AMI and system manufacturer have carefully set up these defaults that provide the best performance and reliability.

4.2 Navigation Keys

The BIOS setup/utility uses a key-based navigation system called hot keys. Most of the BIOS setup utility hot keys can be used at any time during the setup navigation process. These keys include <F1>, <F2>, <Enter>, <ESC>, <Arrow> keys, and so on.



【Note】 : *Some of the navigation keys differ from one screen to another.*

Hot Keys	Descriptions
→← Left/Right	The Left and Right <Arrow> keys allow users to select a setup screen.
↑↓ Up/Down	The Up and Down <Arrow> keys allow users to select a setup screen or sub-screen.
+– Plus/Minus	The Plus and Minus <Arrow> keys allow users to change the field value of a particular setup item.
Tab	The <Tab> key allows users to select setup fields.
F1	The <F1> key allows users to display the General Help screen.
F2	The <F2> key allows users to Load Previous Values.
F3	The <F3> key allows users to Load Optimized Defaults.
F4	The <F4> key allows users to save any changes they made and exit the Setup. Press the <F4> key to save any changes.
Esc	The <Esc> key allows users to discard any changes they made and exit the Setup. Press the <Esc> key to exit the setup without saving any changes.
Enter	The <Enter> key allows users to display or change the setup option listed for a particular setup item. The <Enter> key can also allow users to display the setup sub- screens.

4.3 Main Menu

The Main Menu screen is the first screen users see when entering the setup utility. Users can always return to the Main setup screen by selecting the Main tab. System Time/Date can be set up as described below. The Main BIOS setup screen is also shown below.

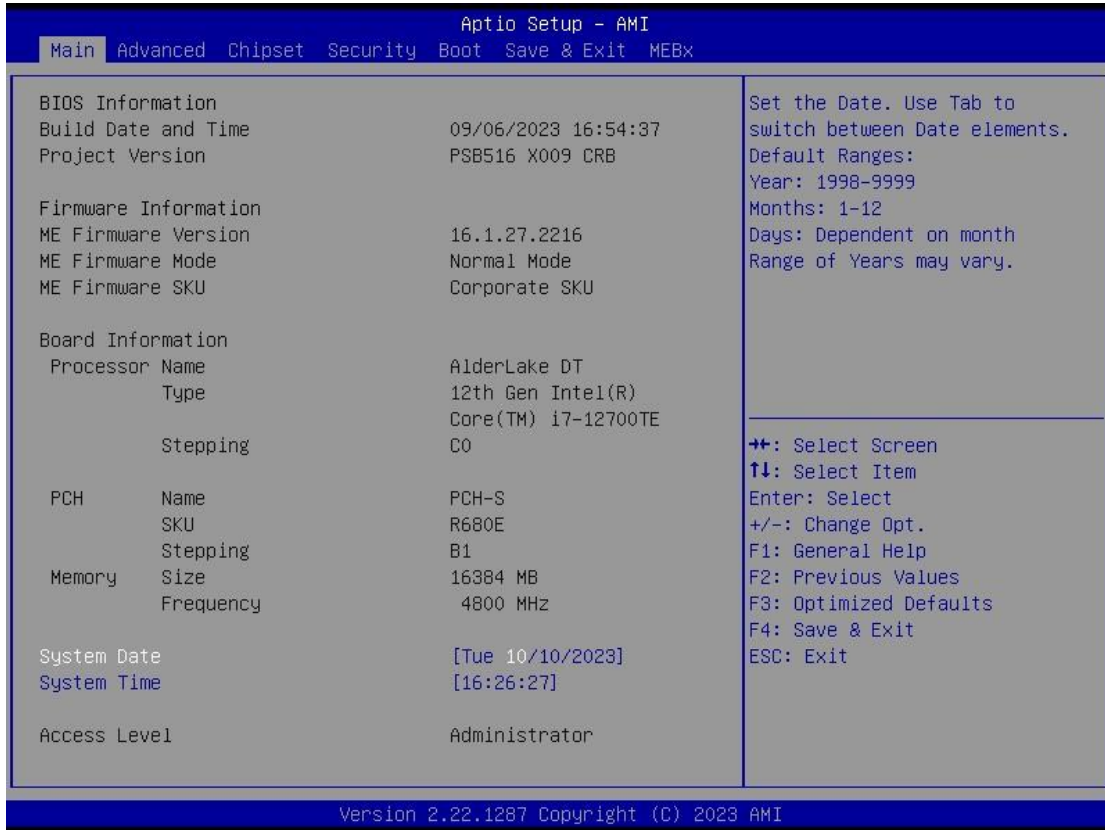

BIOS Information

Display the auto-detected BIOS information.

System Language

Choose the system default language.

System Date/Time

Use this option to change the system time and date. Highlight System Time or System Date using the <Arrow> keys. Enter new values through the keyboard. Press the <Tab> key or the <Arrow> keys to move between fields. The date must be entered in MM/DD/YY format. The time is entered in HH:MM:SS format.

Access Level

Display the access level of current user.

4.4 Advanced Menu

The Advanced menu also allows users to set configuration of the CPU and other system devices. Users can select any items in the left frame of the screen to go to sub menus:

- ▶ Smart Ignition Management
- ▶ ACPI Settings
- ▶ Trust Computing
- ▶ Storage Configuration
- ▶ NVMe Configuration
- ▶ AMT Configuration
- ▶ F81966 Super IO Configuration
- ▶ Hardware Monitor
- ▶ USB Configuration
- ▶ Device Configuration

For items marked with “▶”, please press <Enter> for more options.

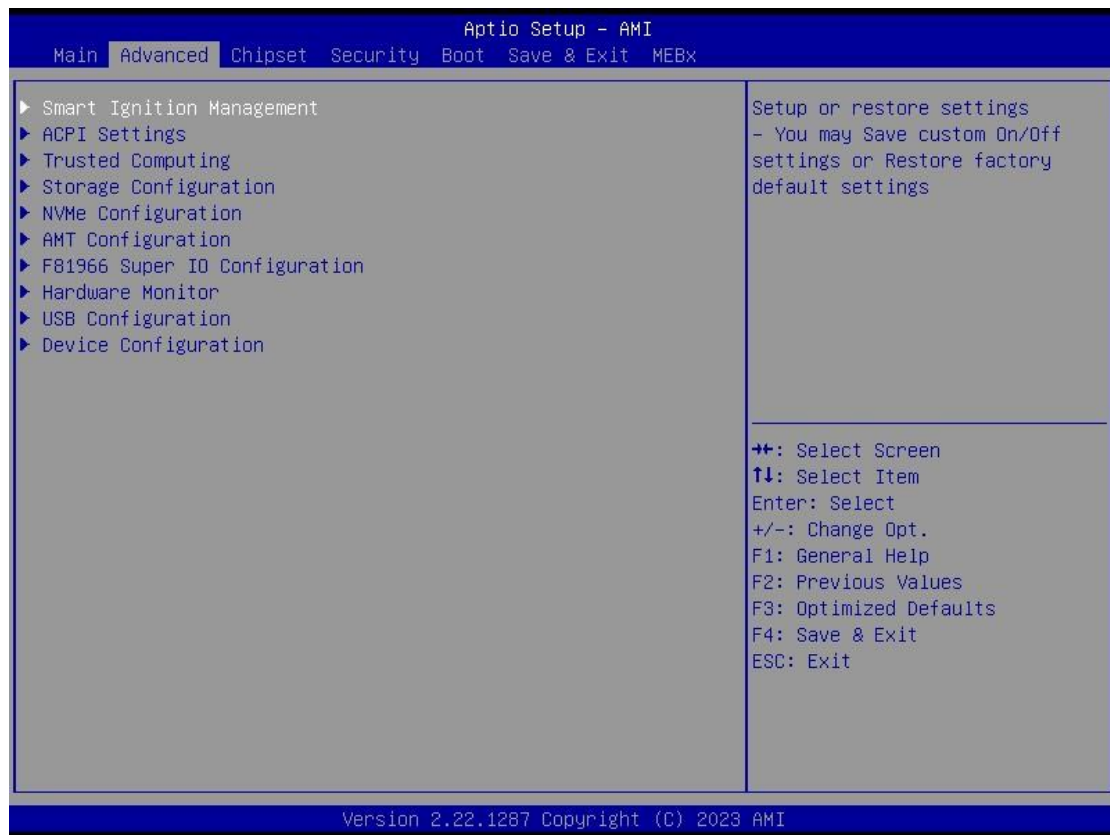

Smart Ignition Management

Press Enter to access the sub-menu. Calculated based on the 24-hour military-time clock.

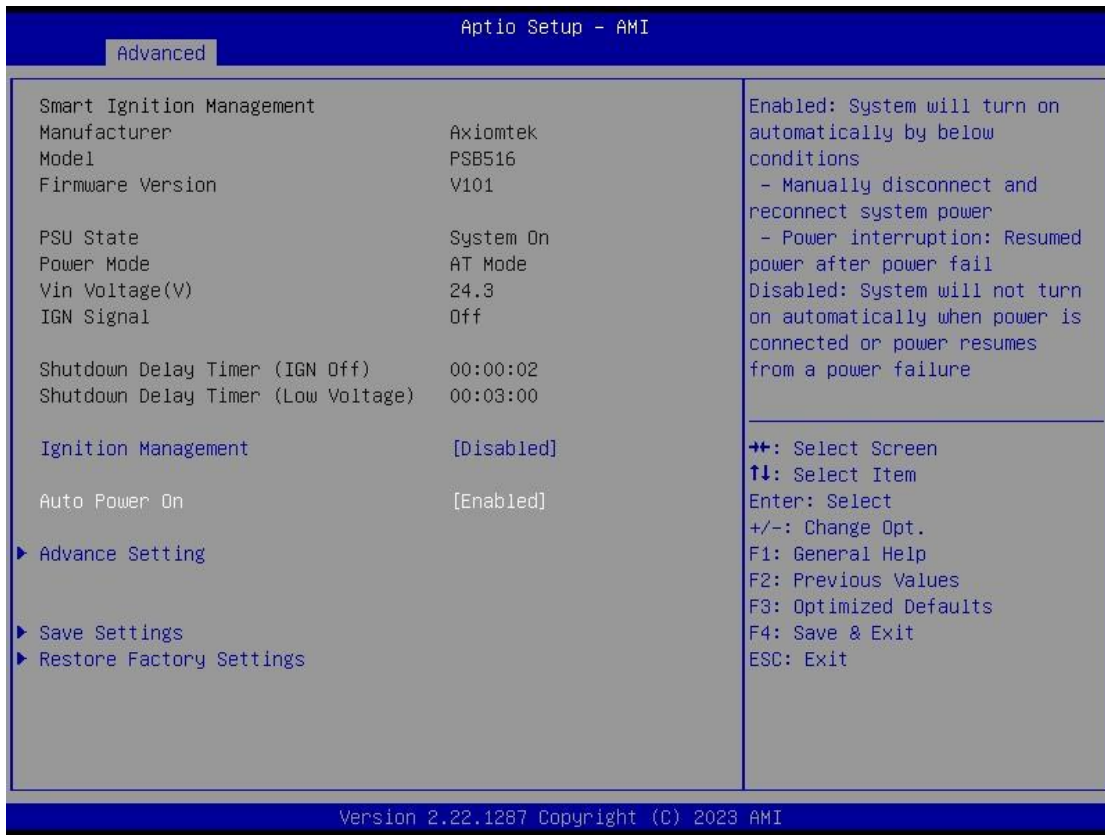

BIOS menu item	Description
Ignition Management	<p>Enabled</p> <p>Switch to ACC mode</p> <p>*Note: IGN signal will only be triggered when DCIN Terminal Block 4-Pin IGN relates to VCC.</p> <p>Disabled</p> <p>Switch to AT mode</p> <p>*Note: System will be reset after Ignition Management setting has been changed and saved.</p>
Auto Power On	<p>Enabled</p> <p>System will turn on automatically under following conditions:</p> <ul style="list-style-type: none"> - Manually disconnects and reconnects system power - Power interruption: Resumes power after power failure <p>Disabled</p>

	System will not turn on automatically when power is connected or when power resumes from a power failure
Advance Setting	Set system on/off timing and voltage threshold levels
Save Settings	Save the current settings
Restore Factory Settings	Restores factory defaults to remove any incorrect or corrupt settings that might have prevented the system from properly powering on/off.

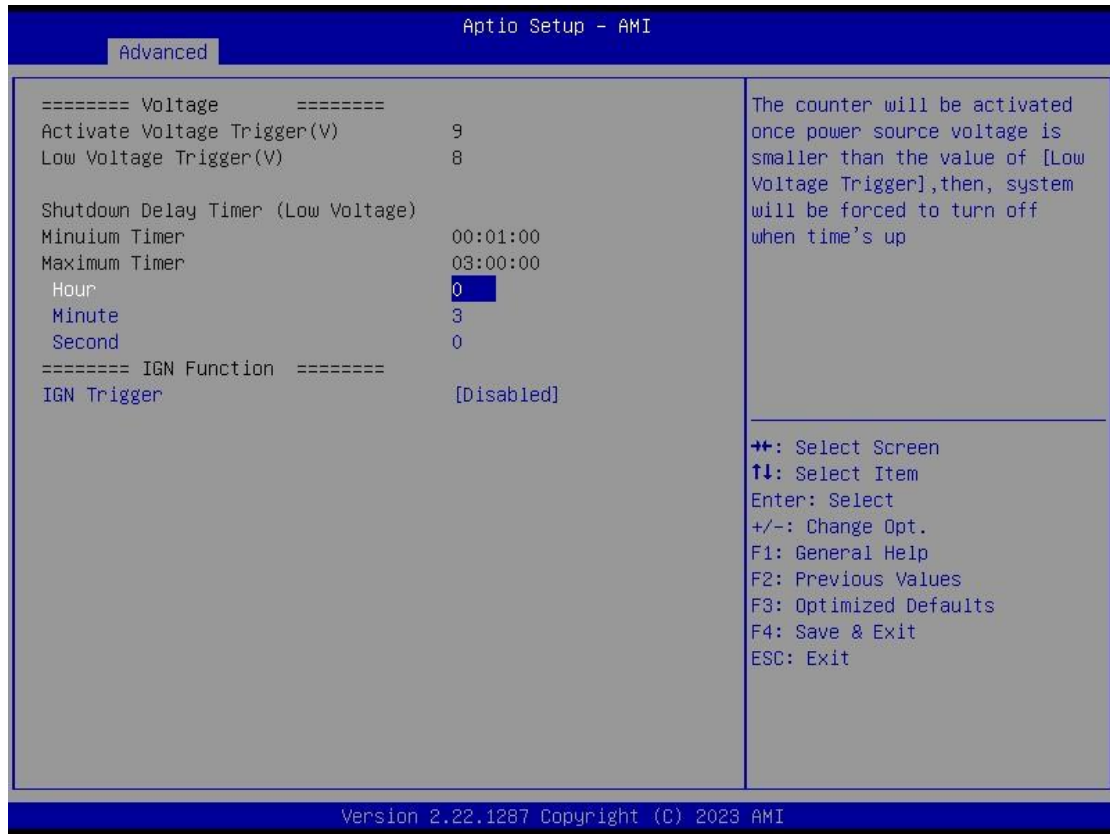

BIOS menu item	Description
Activate Voltage Trigger	The system only turns on when the voltage delivered by the power source is higher than the value you set here.
Low Voltage Trigger	The system will begin countdown stage once voltage drops below the value you set here. If the power source voltage does not come back above the value of [Activate Voltage Trigger] within the time you set for [Shutdown Delay Time (Low Voltage)], the system will shut down and remain off.
Shutdown Delay Timer (Low Voltage)	The counter will be activated once power source voltage drops below the value defined in [Low Voltage Trigger]. The system will be forced to turn off once timer completes countdown.
IGN Trigger	Enable [System Turn On Delay] and [Shutdown Delay] will be triggered by IGN. Disable IGN signal will not affect any power management.

ACPI Settings

Use this screen to select options for the ACPI configuration and change the value of the selected option. A description of the selected item appears on the right side of the screen.

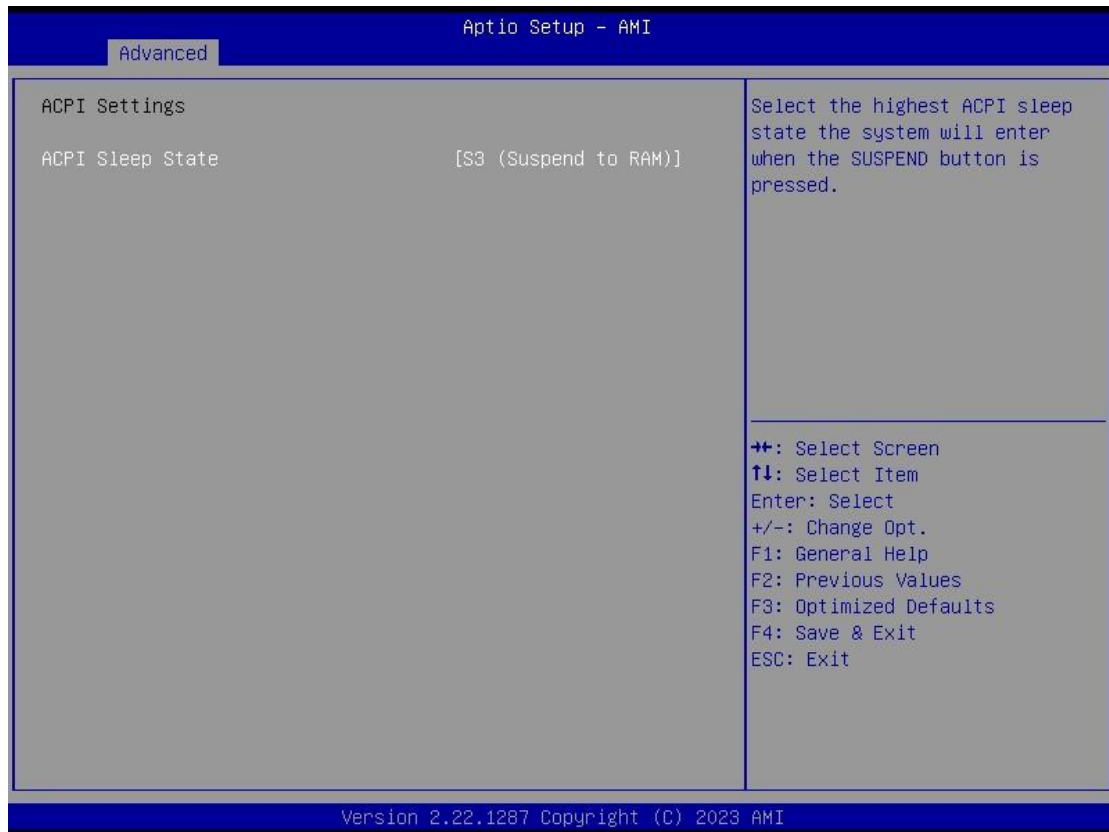

ACPI Sleep State

When the sleep button is pressed, the system will be in the ACPI sleep state.

The default is S3 (Suspend to RAM).

Trust Computing

If users install a security device, such as TPM, users will see the following information for the TPM device and status.

The screenshot shows the 'Advanced' menu in the Aptio Setup - AMI BIOS. The menu is divided into two columns. The left column lists TPM 2.0 Device Found information and Security Device Support options. The right column contains a description of the Security Device Support option and a list of navigation keys.

Advanced		Aptio Setup - AMI
TPM 2.0 Device Found		Enables or Disables BIOS support for security device. O.S. will not show Security Device. TCG EFI protocol and INT1A interface will not be available.
Firmware Version:	1.258	
Vendor:	STM	
Security Device Support	[Enable]	
Active PCR banks	SHA256	
Available PCR banks	SHA256	
		⇐: Select Screen ↑↓: Select Item Enter: Select +/-: Change Opt. F1: General Help F2: Previous Values F3: Optimized Defaults F4: Save & Exit ESC: Exit
Version 2.22.1287 Copyright (C) 2023 AMI		

Storage Configuration

This screen shows the CPU version and its detailed information.



NVMe Configuration

This screen shows NVMe device information.

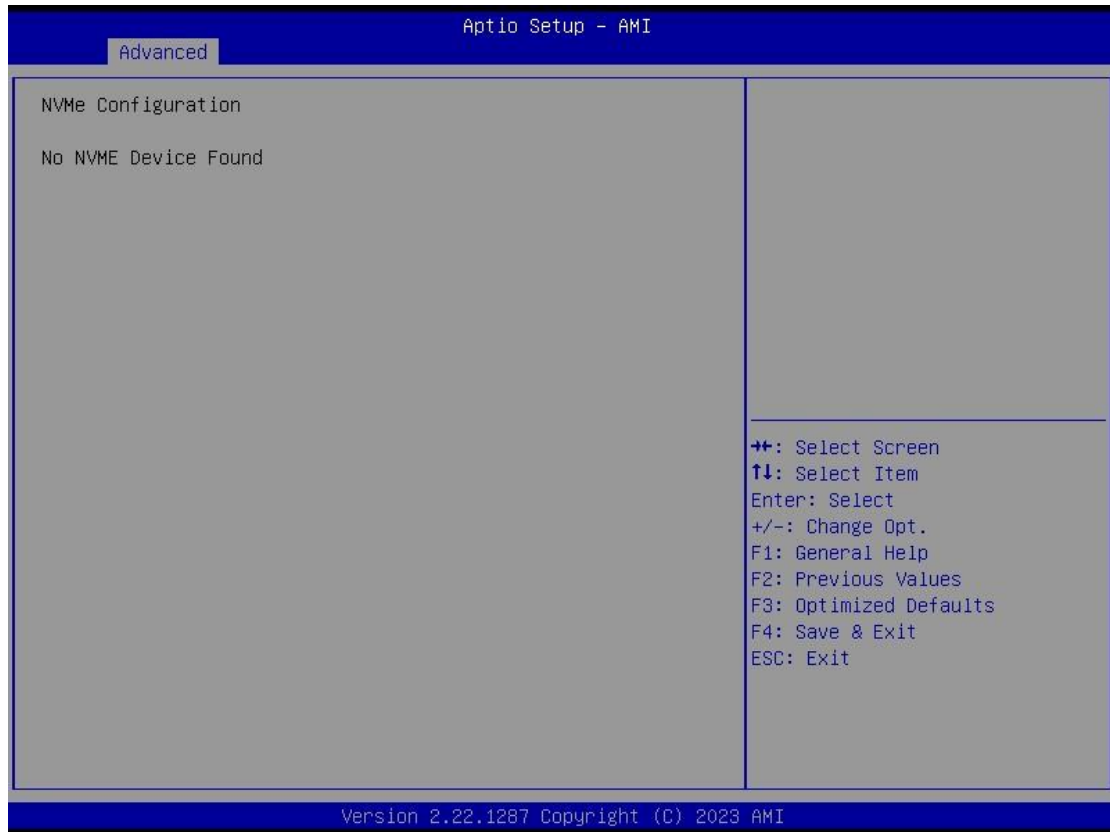

AMT Configurations

Users can use this screen to configure AMT parameters.

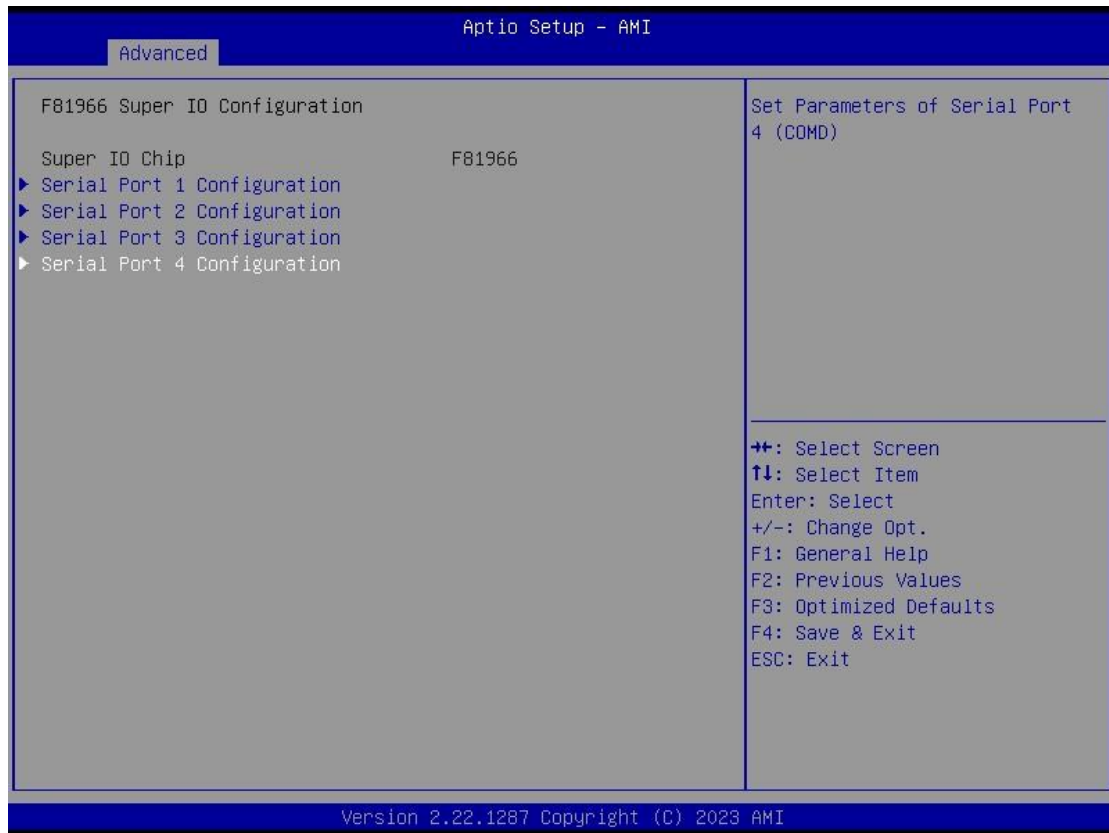

Intel® AMT

Enable or disable Intel® Active Management Technology BIOS Extension.

The default is enabled.

F81966 Super IO Configurations

Use this screen to select options for the F81966 Super IO Configurations and change the value of the selected option. A description of the selected item appears on the right side of the screen. For items marked with “▶”, please press <Enter> for more options

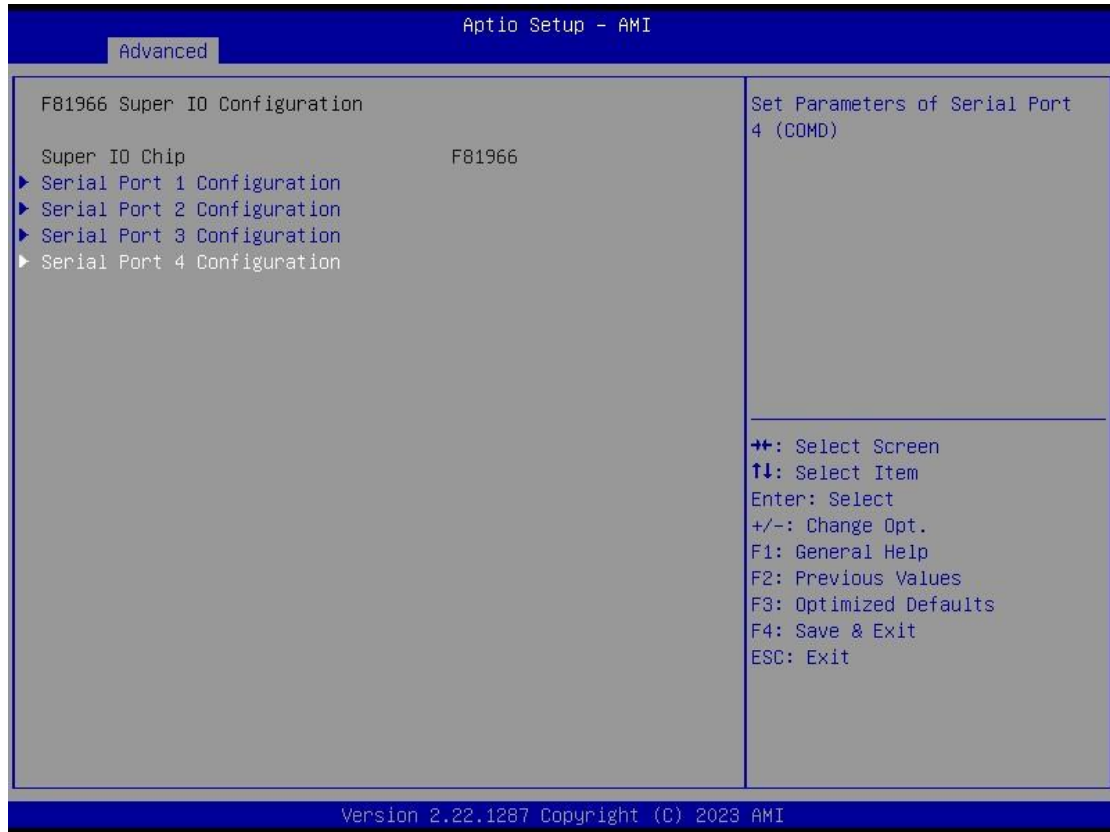

Serial Port 1~4 (COM1~4) Configurations

Use these items to set parameters related to serial ports COM1~2 (RS232/422/485)

Use these items to set parameters related to serial ports COM3~4 (RS232 only)

Serial Port 1

Aptio Setup - AMI

Main

Serial Port 1 Configuration		COM Port Type: RS232, RS422, RS485
Serial Port	[Enabled]	
Device Settings	ID=3F8h; IRQ=4;	
COM Port Type	[RS232]	

COM Port Type

RS232

RS422

RS485

++: Select Screen
 ↑↓: Select Item
 Enter: Select
 +/-: Change Opt.
 F1: General Help
 F2: Previous Values
 F3: Optimized Defaults
 F4: Save & Exit
 ESC: Exit

Version 2.22.1287 Copyright (C) 2023 AMI

Serial Port 2

Aptio Setup - AMI

Main

Serial Port 2 Configuration		COM Port Type: RS232, RS422, RS485
Serial Port	[Enabled]	
Device Settings	ID=2F8h; IRQ=3;	
COM Port Type	[RS232]	

COM Port Type

RS232

RS422

RS485

++: Select Screen
 ↑↓: Select Item
 Enter: Select
 +/-: Change Opt.
 F1: General Help
 F2: Previous Values
 F3: Optimized Defaults
 F4: Save & Exit
 ESC: Exit

Version 2.22.1287 Copyright (C) 2023 AMI

Serial Port 3

Aptio Setup - AMI

Main

Serial Port 3 Configuration

Serial Port [Enabled]
Device Settings IO=3E8h; IRQ=5;

Enable or Disable Serial Port (COM)

++: Select Screen
↑: Select Item
Enter: Select
+/-: Change Opt.
F1: General Help
F2: Previous Values
F3: Optimized Defaults
F4: Save & Exit
ESC: Exit

Version 2.22.1287 Copyright (C) 2023 AMI

Serial Port 4

Aptio Setup - AMI

Main

Serial Port 4 Configuration

Serial Port [Enabled]
Device Settings IO=2E8h; IRQ=6;

Enable or Disable Serial Port (COM)

++: Select Screen
↑: Select Item
Enter: Select
+/-: Change Opt.
F1: General Help
F2: Previous Values
F3: Optimized Defaults
F4: Save & Exit
ESC: Exit

Version 2.22.1287 Copyright (C) 2023 AMI

Hardware Monitor

This screen monitors hardware health status.



This screen displays the temperature of system and CPU as well as system voltages (VCORE, +3V STBY, +5V STBY and +5V).

USB Configurations

This screen shows USB configuration.

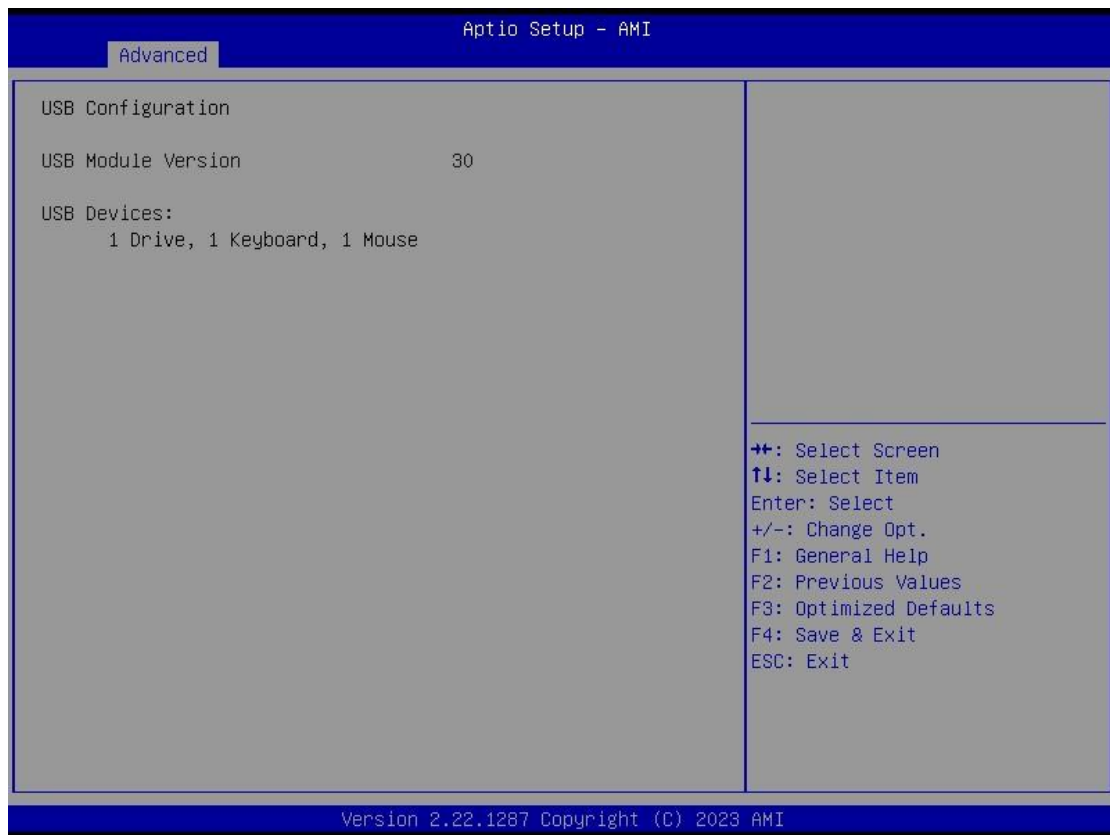

Device Configurations

Users can use this screen to configure Device configurations.



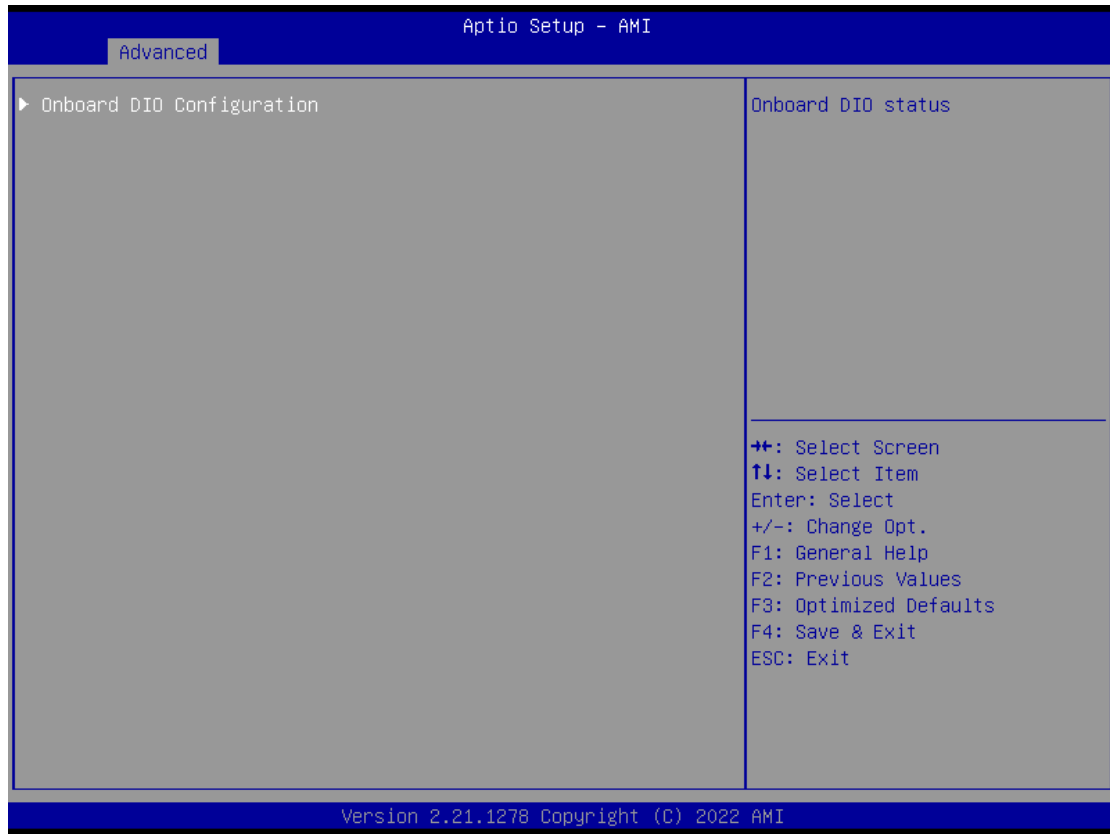

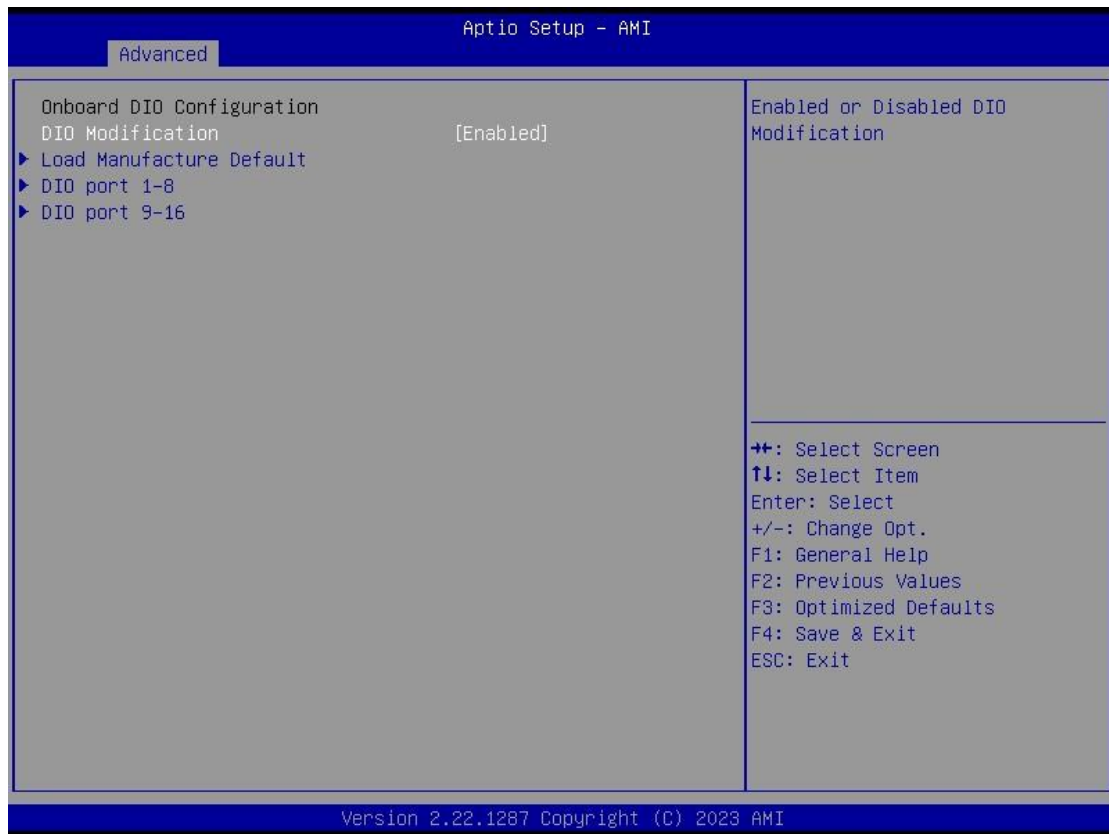

Aptio Setup - AMI		
Main		
DIO status		Input/Output Setting
1. Input/Output Status	Out & Low	
Input/Output Setting	[Output]	
High/Low Setting	[Low]	
2. Input/Output Status	Out & Low	
Input/Output Setting	[Output]	
High/Low Setting	[Low]	
3. Input/Output Status	Out & Low	
Input/Output Setting	[Output]	
High/Low Setting	[Low]	
4. Input/Output Status	Out & Low	
Input/Output Setting	[Output]	
High/Low Setting	[Low]	
5. Input/Output Status	In & High	++: Select Screen
Input/Output Setting	[Input]	↑↓: Select Item
6. Input/Output Status	In & High	Enter: Select
Input/Output Setting	[Input]	+/-: Change Opt.
7. Input/Output Status	In & High	F1: General Help
Input/Output Setting	[Input]	F2: Previous Values
8. Input/Output Status	In & High	F3: Optimized Defaults
Input/Output Setting	[Input]	F4: Save & Exit
		ESC: Exit
Version 2.22.1287 Copyright (C) 2023 AMI		

4.5 Chipset Menu

The Chipset menu allows users to change the advanced chipset settings. Users can select any of the items in the left frame of the screen to go to the sub menus:

- ▶ System Agent (SA) Configurations
- ▶ PCH-IO Configurations

For items marked with “▶”, please press <Enter> for more options.



System Agent (SA) Configurations



VT-d

VT-d capability.

Above 4GB MMIO BIOS assignment

Enable/Disable above 4GB Memory Mapped IO BIOS assignment. This is enabled automatically when Aperture Size is set to 2048MB.

Graphics Configuration

Use this item to configure internal graphics controller.

Graphic Configurations

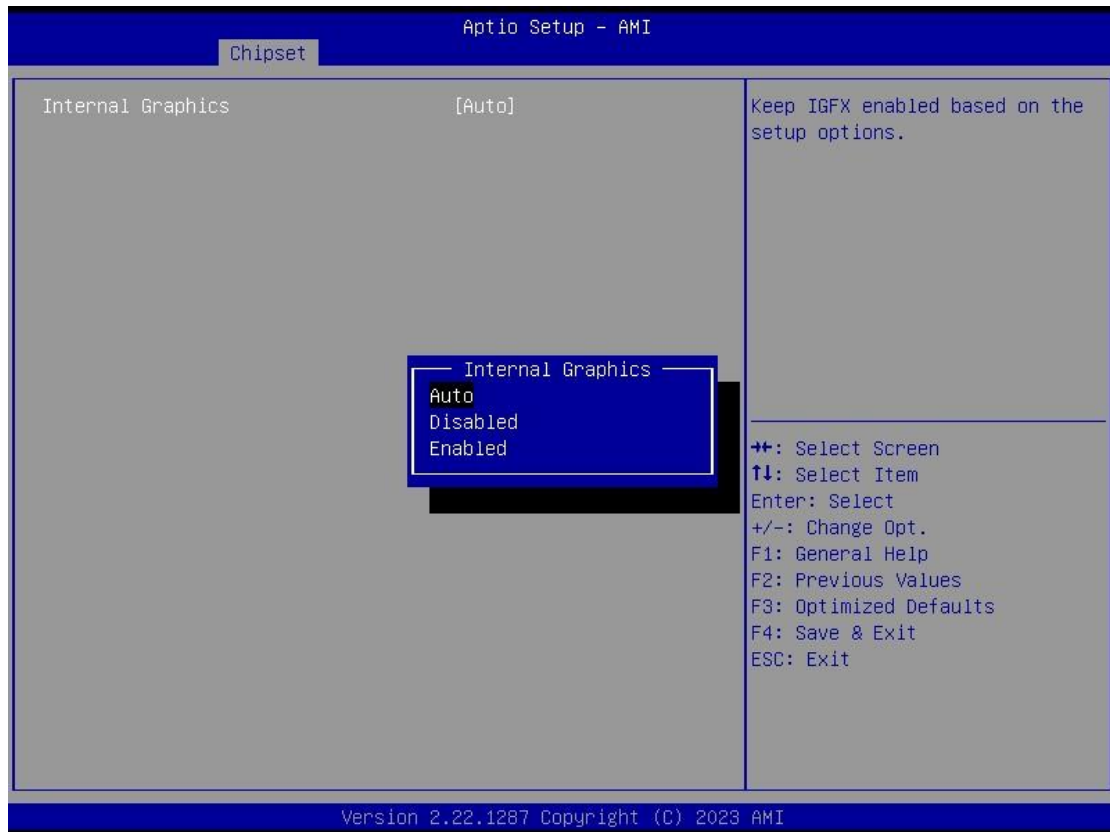

Internal Graphics

Keep IGFX enabled based on the setup options.

PCH-IO Configurations

This screen allows users to set PCH parameters.

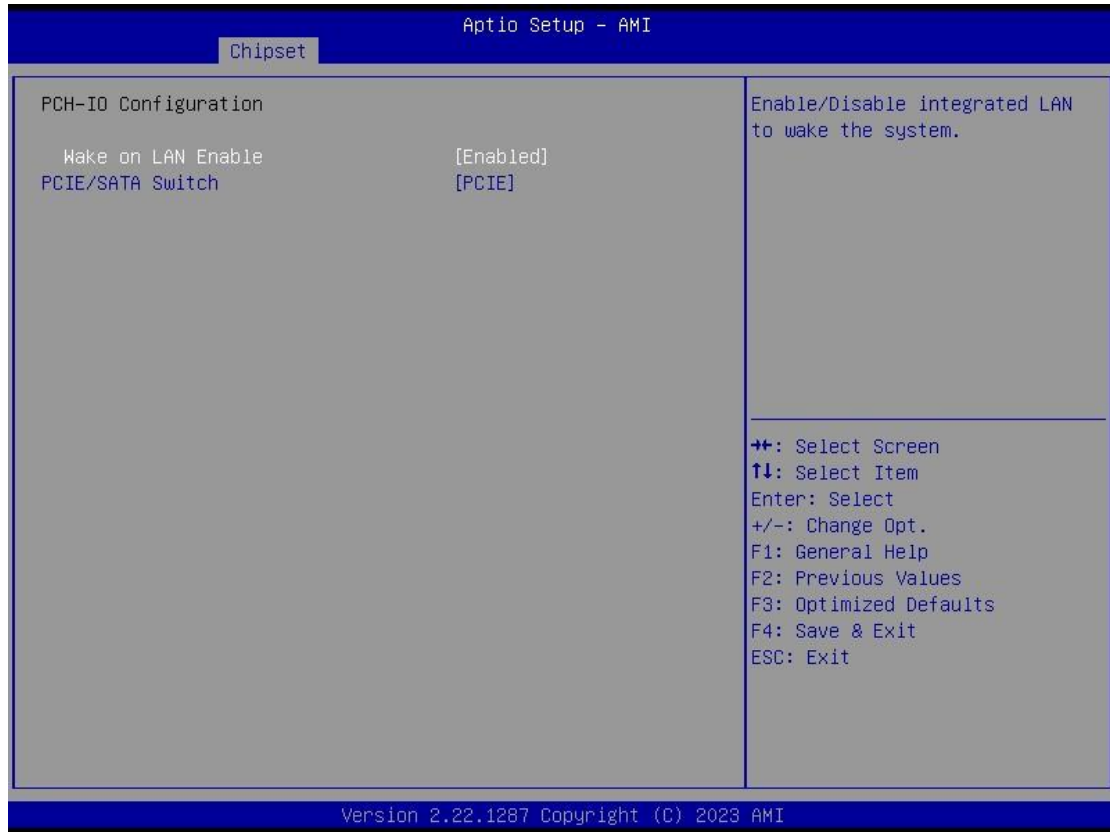

Wake on LAN Enable

Enable or disable integrated LAN to wake the system.

PCIE/SATA Switch

Enable or disable integrated LAN to wake the system.

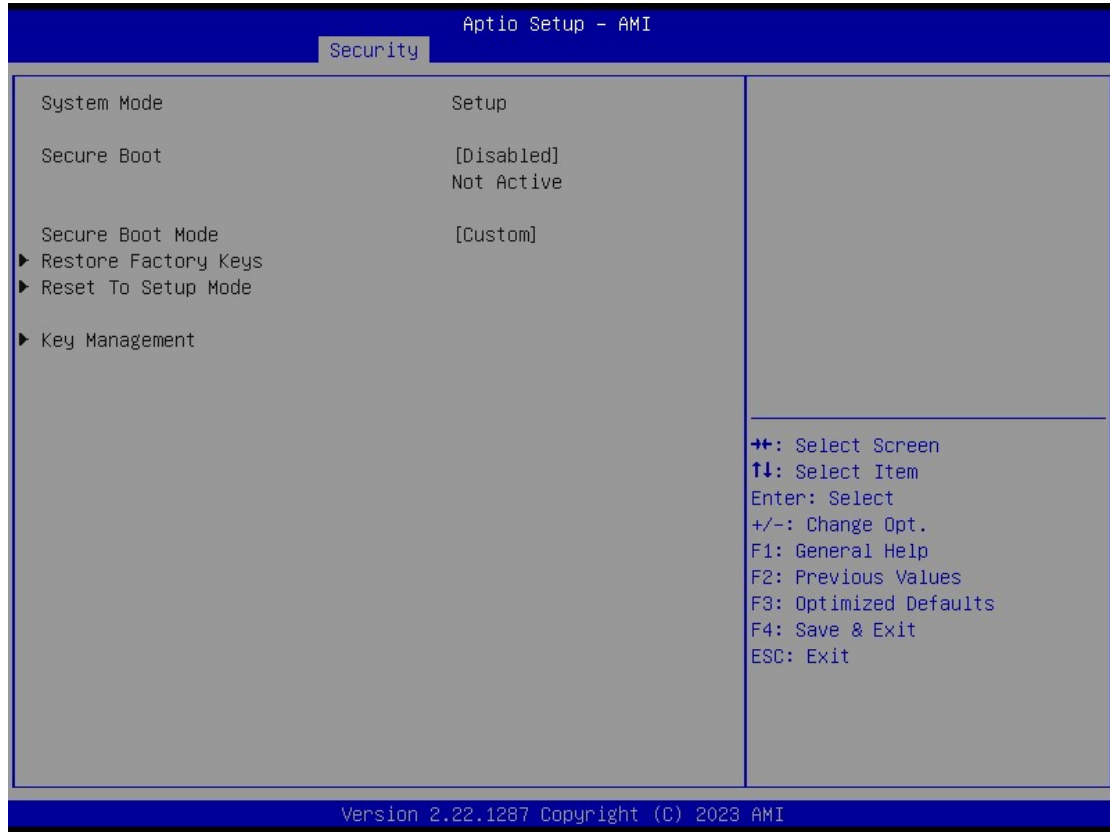

Secure Boot Mode

Use this item to set UEFI Secure Boot Mode to Standard mode or Custommode. This change is effective after save. After reset, this mode will return to Standardmode.

Restore Factory Keys

Use this item to force System to User Mode, to install factory default SecureBoot key databases.

Reset To Setup Mode

Select Yes and press <Enter> to restore the manufacturer default Secure Boot keys. This will also reset the system to User mode. The options are Yes and No.

Key Management

Enables expert users to modify Secure boot policy variables without full authentication.

4.6 Boot Menu

The Boot menu allows users to change boot options of the system.

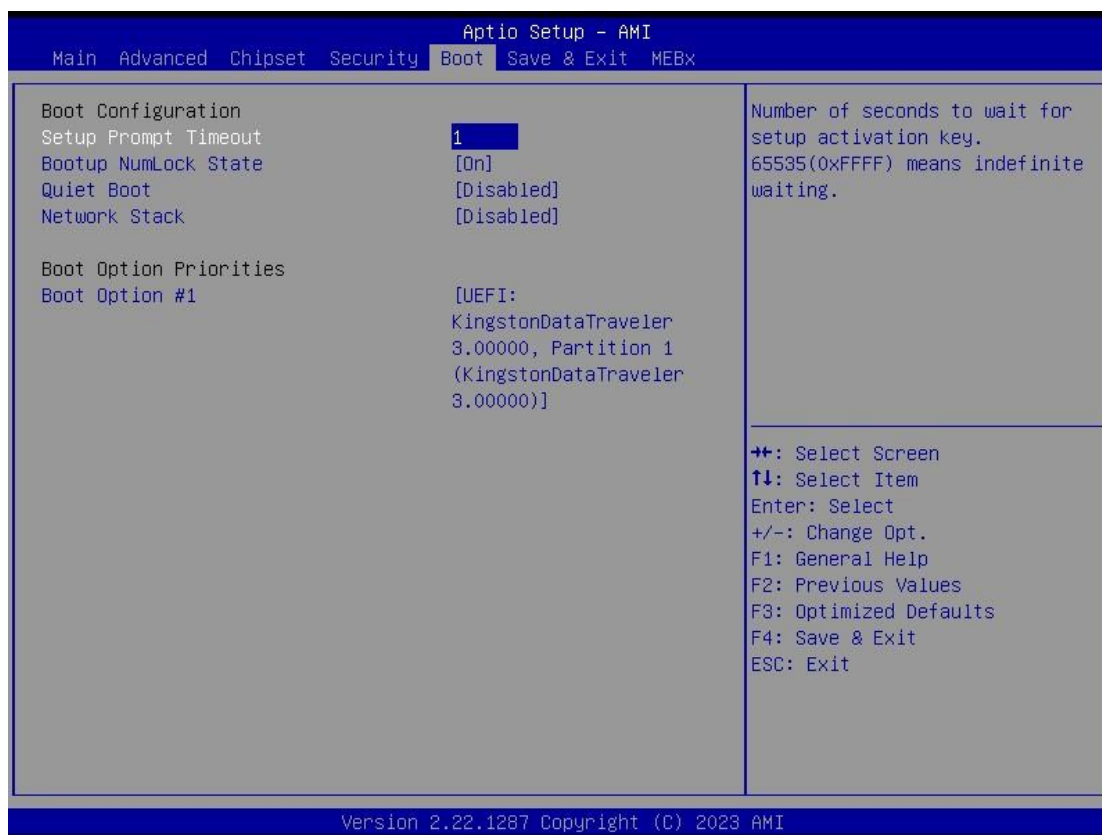

Setup Prompt Timeout

Use this item to set up number of seconds to wait for setup activation key where 65535(0xFFFF) means indefinite waiting.

Bootup NumLock State

Use this item to select the power-on state for the keyboard NumLock.

Quiet Boot

Select to display either POST output messages or a splash screen during boot-up.

Boot Option Priorities

These are settings for boot priority. Specify the boot device priority sequence from the available devices.

4.7 Save & Exit Menu

The Save & Exit menu allows users to load system configurations with optimal or fail-safe default values.

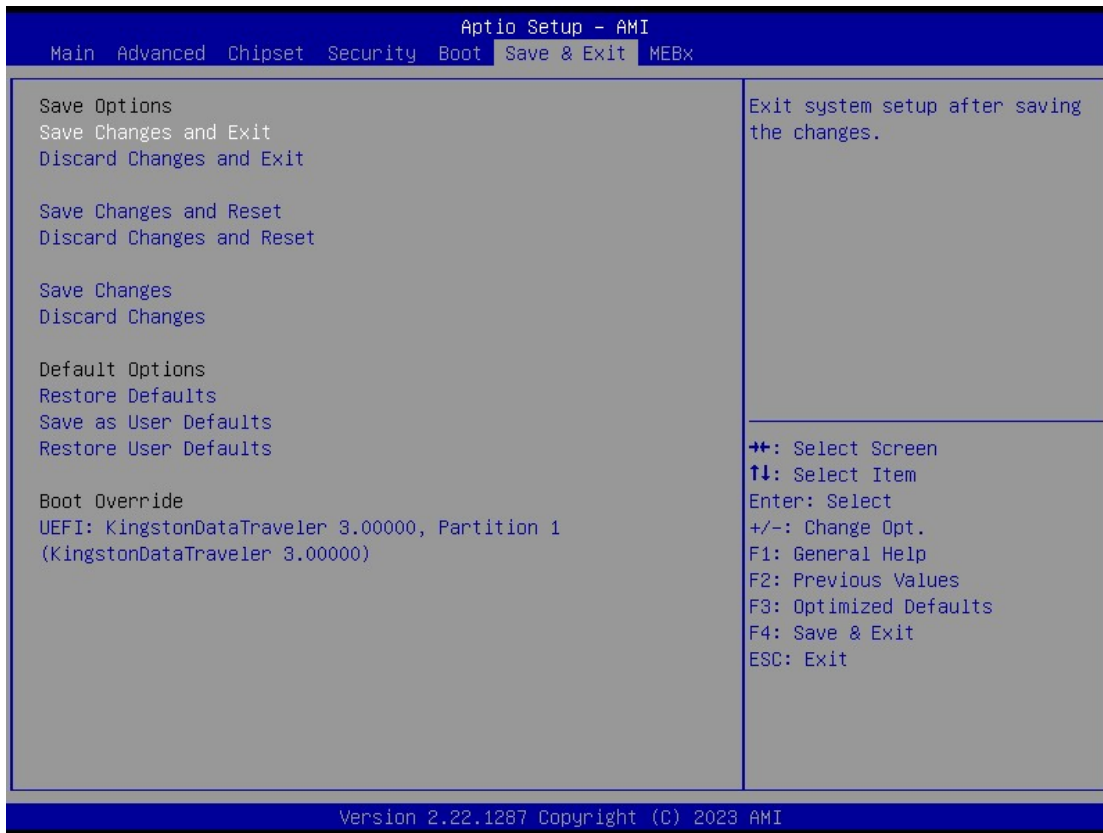

Save Changes and Exit

When users have completed the system configuration changes, select this option to leave Setup and return to Main Menu. Select Save Changes and Exit from the Save & Exit menu and press <Enter>. Select Yes to save changes and exit.

Discard Changes and Exit

Select this option to quit Setup without making any permanent changes to the system configurations and return to Main Menu. Select Discard Changes and Exit from the Save & Exit menu and press <Enter>. Select Yes to discard changes and exit.

Save Changes and Reset

Having completed the system configuration changes, select this option to leave Setup and reboot the computer so the new system configurations take effect. Select Save Changes and Reset from the Save & Exit menu and press <Enter>. Select Yes to save changes and reset.

Discard Changes and Reset

Select this option to quit Setup without making any permanent changes to the system configuration and reboot the computer. Select Discard Changes and Reset from the Save & Exit menu and press <Enter>. Select Yes to discard changes and reset.

Save Changes

Having completed the system configuration changes, select this option to save changes. Select Save Changes from the Save & Exit menu and press <Enter>. Select Yes to save changes.

Discard Changes

Select this option to quit Setup without making any permanent changes to the system configurations. Select Discard Changes from the Save & Exit menu and press <Enter>. Select Yes to discard changes.

Restore Defaults

It automatically sets all Setup options to a complete set of default settings when users select this option. Select Restore Defaults from the Save & Exit menu and press <Enter>.

Save as User Defaults

Select this option to save system configuration changes done so far as User Defaults. Select Save as User Defaults from the Save & Exit menu and press <Enter>.

Restore User Defaults

It automatically sets all Setup options to a complete set of User Defaults when users select this option. Select Restore User Defaults from the Save & Exit menu and press <Enter>.

Boot Override

Select a drive to immediately boot that device regardless of the current boot order.

This page is intentionally left blank.

APPENDIX A WATCHDOG TIMER

A.1 About Watchdog Timer

Software stability is major issue in most application. Some embedded systems are not watched by human for 24 hours. It is usually too slow to wait for someone to reboot when computer hangs. The systems need to be able to reset automatically when things go wrong. The watchdog timer gives us solution.

The watchdog timer is a counter that triggers a system reset when it counts down to zero from a preset value. The software starts counter with an initial value and must reset it periodically. If the counter ever reaches zero which means the software has crashed, the system will reboot.

A.2 Sample Program

```
#include "stdafx.h"
#include <windows.h>
#include <stdio.h>
#include <tchar.h>
#include <stdlib.h>

#ifdef _DEBUG
#define new DEBUG_NEW
#endif

#pragma comment (lib, "User32.lib" )

#define IDT_TIMER WM_USER + 200
#define _CRT_SECURE_NO_WARNINGS 1
#define setbit(value,x) (value |= (1<<x))
#define clrbit(value,x) (value &= ~(1<<x))

HINSTANCE hinstLibDLL = NULL;
```

```
LONG WDTDATA = 0;

typedef ULONG(*LPFNDDLGETIOSPACE)(ULONG);
LPFNDDLGETIOSPACE lpFnDII_Get_IO;
typedef void(*LPFNDDLSETIOSPACE)(ULONG, ULONG);
LPFNDDLSETIOSPACE lpFnDII_Set_IO;

int _tmain(int argc, _TCHAR* argv[])
{
    int unit = 0;
    int WDTtimer = 0;
    if (hinstLibDLL == NULL)
    {
        hinstLibDLL = LoadLibrary(TEXT("diodll.dll"));
        if (hinstLibDLL == NULL)
        {
            //MessageBox("Load diodll dll error", "", MB_OK);
        }
    }

    if (hinstLibDLL)
    {
        lpFnDII_Get_IO = (LPFNDDLGETIOSPACE)GetProcAddress(GetModuleHandle("diodll.dll"),
            "GetIoSpaceByte");
        lpFnDII_Set_IO = (LPFNDDLSETIOSPACE)GetProcAddress(GetModuleHandle("diodll.dll"),
            "SetIoSpaceByte");
    }

    printf("Input Watch Dog Timer type, 1:Second ; 2:Minute :");
    scanf("%d",&unit);
    printf("\nInput Timer to countdown:");
    scanf("%d", &WDTtimer);
    printf("Start to countdown...");

    //==Enter MB Pnp Mode==
    lpFnDII_Set_IO(0x2e, 0x87);
    lpFnDII_Set_IO(0x2e, 0x87);
    lpFnDII_Set_IO(0x2e, 0x07);
    lpFnDII_Set_IO(0x2f, 0x07); //SET LDN 07
```

```
//set LDN07 FA 10 to 11
lpFnDII_Set_IO(0x2e, 0xFA);
WDTDATA = lpFnDII_Get_IO(0x2f);
WDTDATA = setbit(WDTDATA, 0);
lpFnDII_Set_IO(0x2f, WDTDATA);
if (unit == 1)
{
lpFnDII_Set_IO(0x2e, 0xF6);
lpFnDII_Set_IO(0x2f, WDTtimer);

//start watchdog counting
lpFnDII_Set_IO(0x2e, 0xF5);
WDTDATA = lpFnDII_Get_IO(0x2f);
WDTDATA = setbit(WDTDATA, 5);
lpFnDII_Set_IO(0x2f, WDTDATA);
}
else if (unit == 2)
{
//set WDT Timer
lpFnDII_Set_IO(0x2e, 0xF6);
lpFnDII_Set_IO(0x2f, WDTtimer);
//set watchdog time unit to min
lpFnDII_Set_IO(0x2e, 0xF5);
WDTDATA = lpFnDII_Get_IO(0x2f);
WDTDATA = setbit(WDTDATA, 3);
lpFnDII_Set_IO(0x2f, WDTDATA);
//start watchdog counting
lpFnDII_Set_IO(0x2e, 0xF5);
WDTDATA = lpFnDII_Get_IO(0x2f);
WDTDATA = setbit(WDTDATA, 5);
lpFnDII_Set_IO(0x2f, WDTDATA);
}
system("pause");
return 0;
}
```

This page is intentionally left blank.

APPENDIX B CONFIGURING SATA FOR RAID

B.1 Configuring SATA Hard Drive(s) for RAID (Controller: Intel® R680E)

Before you begin the SATA configuration, please prepare:

- Two SATA hard drives (to ensure optimal performance, it is recommended that you use two hard drives with identical model and capacity). If you do not want to create RAID with the SATA controller, you may prepare only one hard drive.

Please follow up the steps below to configure SATA hard drive(s):

1. Install SATA hard drive(s) in your system.
2. Enter the BIOS Setup to configure SATA controller mode and boot sequence.
3. Configure RAID by the RAID BIOS.

1. Installing SATA hard drive(s) in your system.

Connect one end of the SATA signal cable to the rear of the SATA hard drive, and the other end to available SATA port(s) on the board. Then, connect the power connector of power supply to the hard drive.

2. Configuring SATA controller mode and boot sequence by the BIOS Setup.

You have to make sure whether the SATA controller is configured correctly by system BIOS Setup and set up BIOS boot sequence for the SATA hard drive(s).

- 2.1. Turn on your system, and then press the button to enter BIOS Setup during running POST (Power-On Self-Test). If you want to create RAID, just go to the Advanced Settings menu\VMD Configuration, enabled the “Enable VMD controller”, save and exit the BIOS Setup.

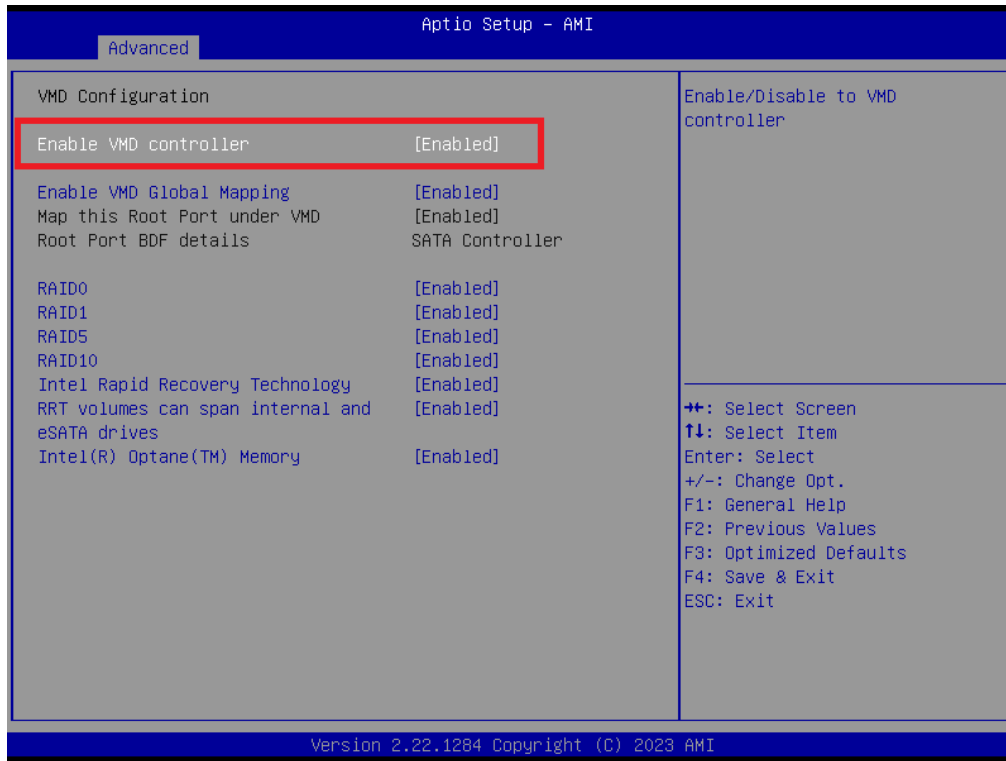

- 2.2. After restart, press button to enter BIOS Setup Menu. In Advanced Page, choose Intel(R) Rapid Storage Technology.

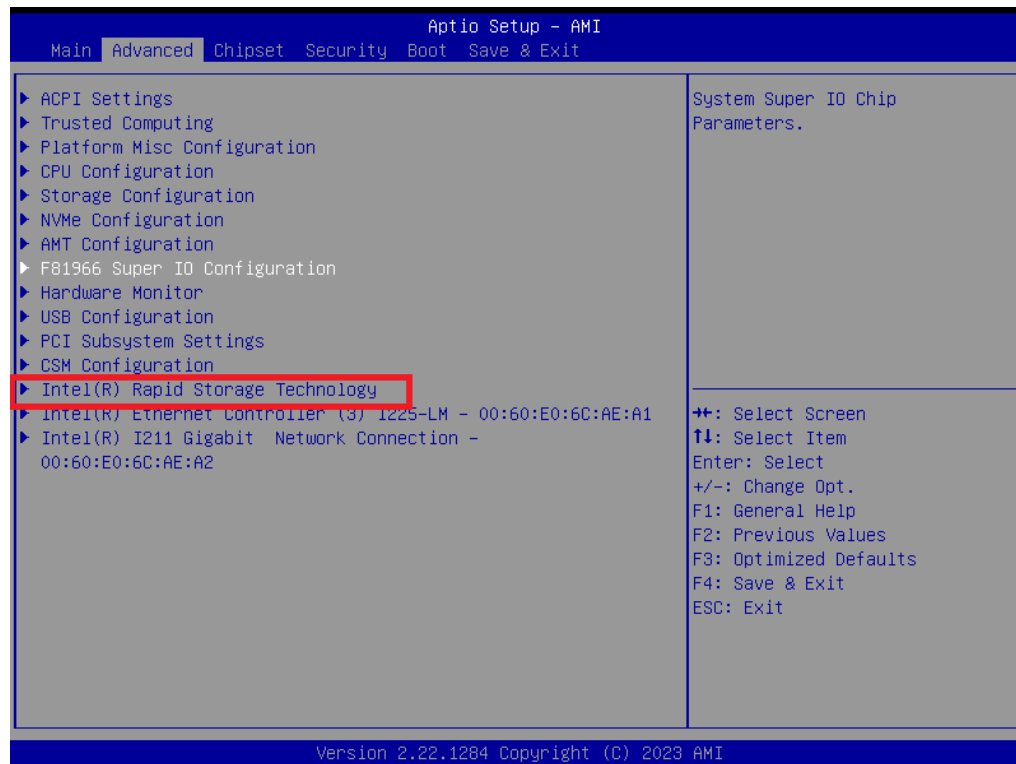

2.3. After restart, press button to enter BIOS Setup Menu. In Advanced Page, select Intel(R) Rapid Storage Technology.

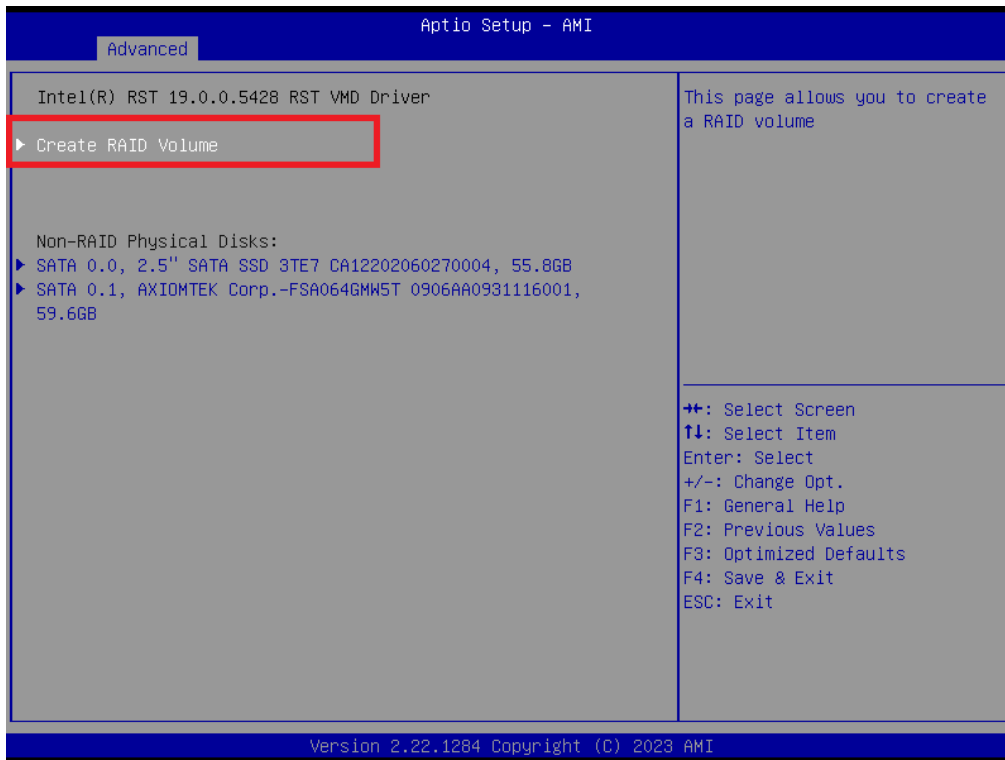

2.4. Select the storage that to be used to RAID function.

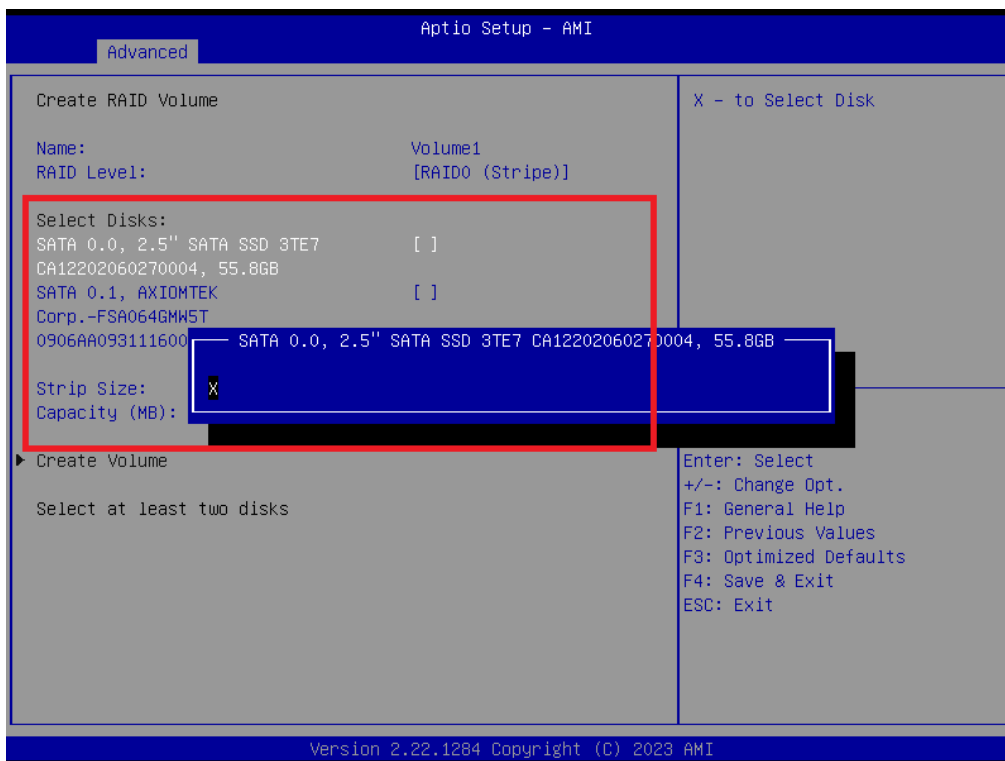

And press <Create volume>

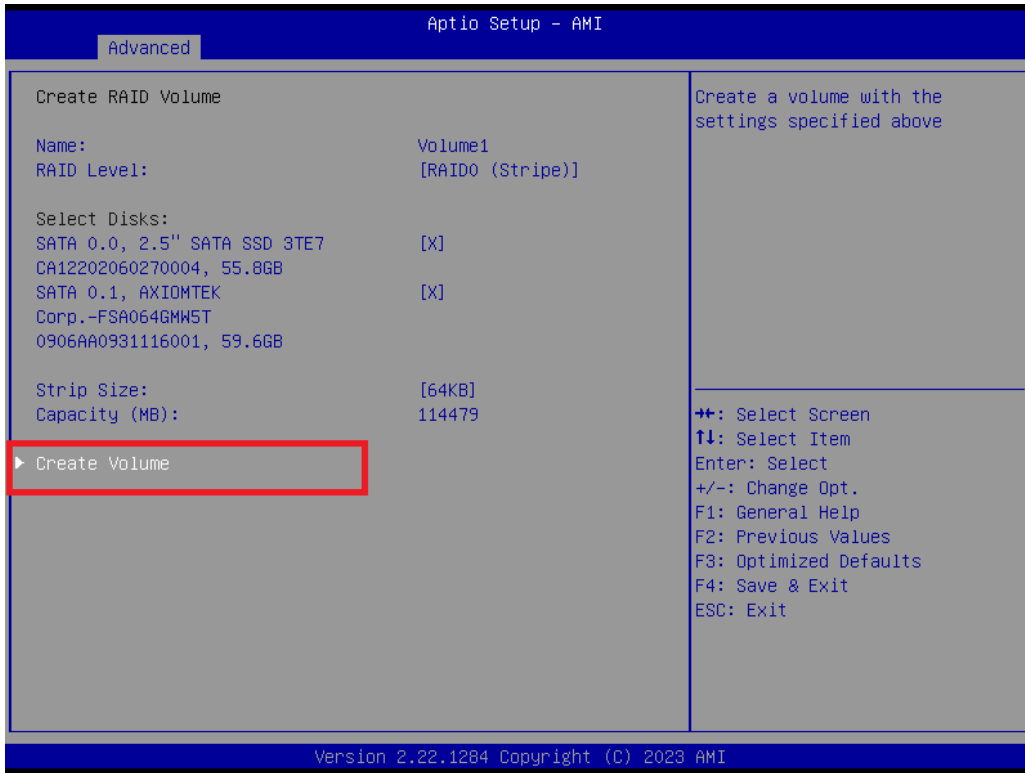

2.6 Install OS. Click Load Driver.

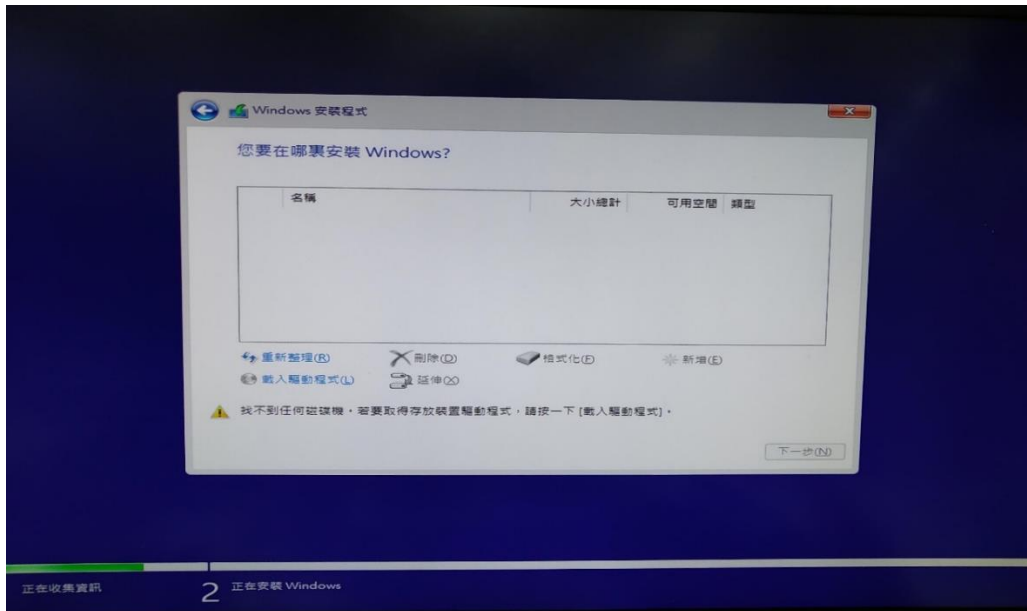

2.7 Click Browse, Find the VMD File and choose "f6vmdflpy.x64".

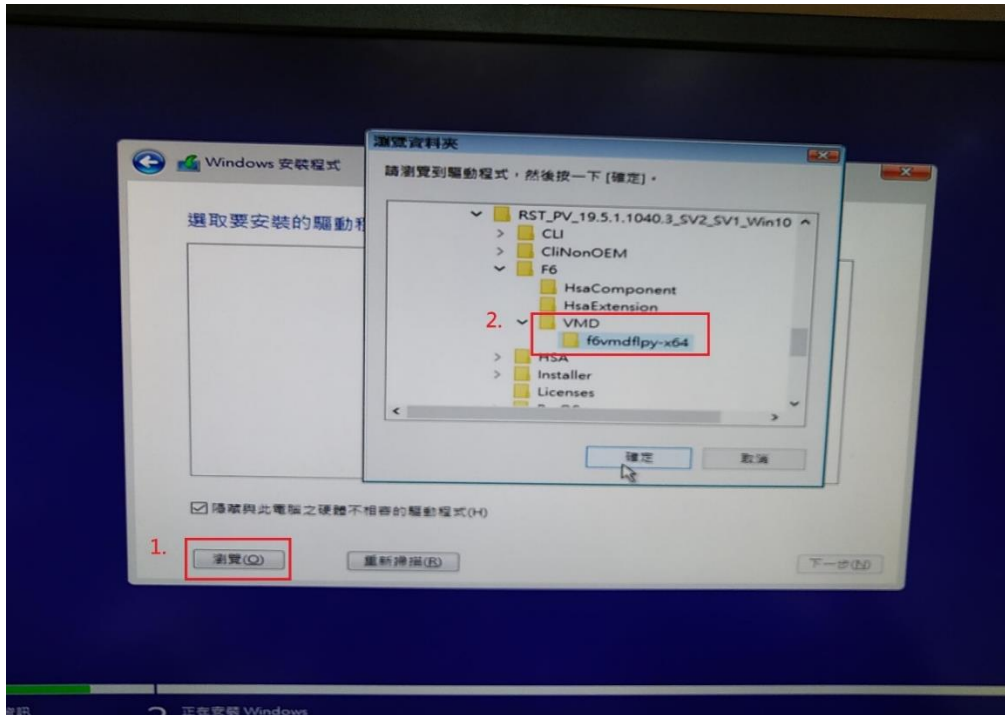

2.8 Press NextStep.

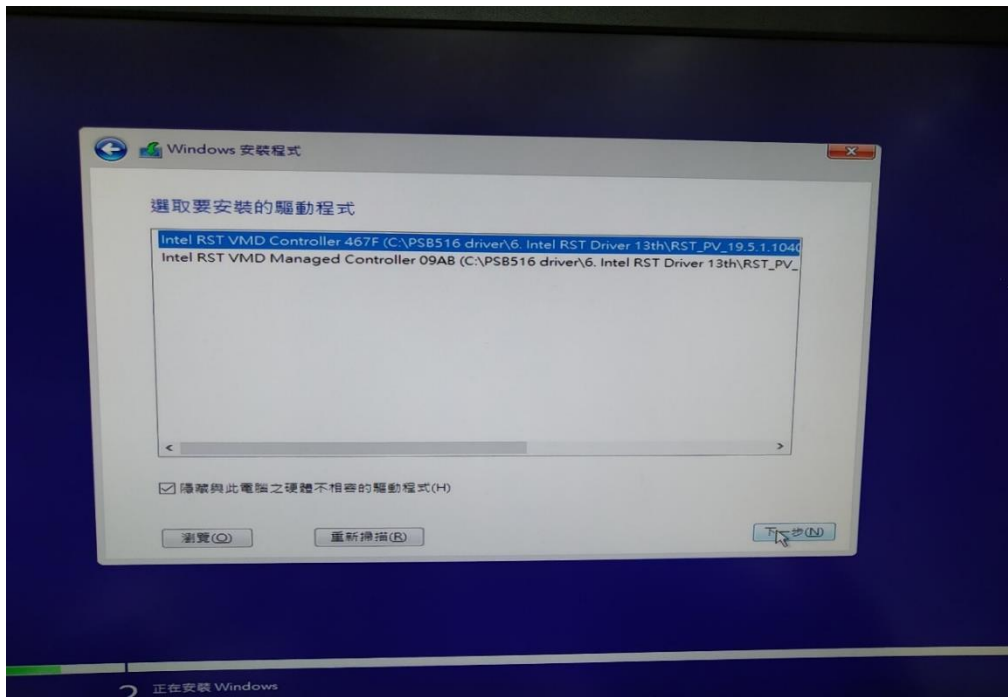

2.9 The storage will be detected after the previous steps.

